

ARIK

ENVY COLLECTION
2021 PRICE LIST

General & Finish Information	2
Typical Configurations	4
Fixed Desks	10
Fixed Worksurfaces	12
Fixed Supports	14
Fixed Credenzas	15
ASIST Desks	18
ASIST Supports	20
ASIST Credenzas	21
Storage Towers	22
Overhead Storage	24
Fabric Tack Panels	25
Wall Panels	27
Wall Panel Shelves	28
Bookcases	40

GENERAL & FINISH INFORMATION

PRICES

All prices are list prices and are effective the date printed on cover and supersedes previous price lists.

Prices shown are for standard product only. Standard product will have additional charges applied to it for any changes made. Architectural Response Kollection, Inc. reserves the right to change prices and specifications without prior notice. Pricing shown does not include installation, taxes, packaging, crating or storage. Orders are acknowledged with net prices. Minimum order charge is \$50.00 net.

ACKNOWLEDGMENT

Each order will be acknowledged. This acknowledgment is the final agreement between Architectural Response Kollection, Inc. and the customer, superseding all previous communications regarding the order.

Orders are subject to acquiring the materials required for manufacturing. Fulfillment can be affected by strikes, fires, embargoes and acts of government. These elements are beyond our control.

PAYMENT TERMS

Terms are Net 30 days. Credit references and resale certificate must be submitted prior to receipt of your initial order. Open account status or terms of sale may be established at the discretion of Architectural Response Kollection, Inc. After 30 days from date of invoice a 1 ½% interest charge will be added on any unpaid balance. Architectural Response Kollection, Inc. may retain a security interest in the furniture until full payment of the invoice.

ORDERING PROCEDURES

Before placing your order, confirm you have all required information necessary. Lead times for orders begin after all required information is included and signed drawings are received. Orders should be submitted through our authorized Factory Representative or may be sent via email to info@ark-inc.com. Contact information Tel. 714.241.7100 Toll-free 888.241.7100.

PRODUCT DESIGN

Architectural Response Kollection, Inc. reserves the right to make changes in design and construction or discontinue without prior notice.

CANCELLATIONS AND CHANGES

Request for cancellation must be in written form and reviewed by Architectural Response Kollection, Inc. if they are of a reasonable nature prior to the start of processing. Processing includes but is not limited to development of shop drawings and other engineering drawings. If cancellation is approved, a processing fee of 25% or more may be imposed based on the status of the order.

Special Product orders may NOT be canceled once entered into production.

Architectural Response Kollection, Inc. will make every attempt to honor any reasonable change request to product provided once the request is received prior to start of production. Request must be made in writing and received in time to make the change. Architectural Response Kollection, Inc. reserves the right to increase our acknowledged price and ship date if necessary to make the requested changes.

PACKING

All prices are for blanket wrap. For special packing requirements, contact customer service. All weights stated herein are approximate. All products are shipped according to freight regulations. The ordering party bears the risk of loss or damage during shipment.

DELIVERY & FREIGHT CHARGES

All shipments are FAS point of shipment, freight prepaid and allowed to one continental U.S. destination. All shipments outside the continental U.S. will be shipped FAS origin, freight prepaid to point of embarkation. All charges beyond point of embarkation are collect. Orders in production will be shipped as scheduled and cannot be delayed. The customer obtains title to their product and materials, and assumes the risk of loss for them, upon shipment from Architectural Response Kollection, Inc. facilities.

Architectural Response Kollection, Inc. reserves the right to select the most appropriate carrier and routing for all shipments.

STORAGE

Architectural Response Kollection, Inc. has no storage facilities for finished product. If a customer cannot accept an order when it is ready for shipment, the customer will be charged 1 ½% of invoice for every 30 days or any part thereof, that merchandise remains in facility.

Architectural Response Kollection, Inc. is not liable for any delay for failure to deliver products due to fires, floods, accidents, labor strikes, lock outs, earthquakes, delay of or failure of material supply sources, acts of God, or any other causes beyond Architectural Response Kollection, Inc.'s control.

CLAIMS

Architectural Response Kollection, Inc. takes every precaution to assure proper inspection of the loading and packaging of all merchandise. Our liability ceases when we receive a clear bill of lading at our shipping dock. This is an acknowledgment by the transportation company that the merchandise was received in good condition.

DAMAGED MERCHANDISE

Do not refuse merchandise damaged in transit. All shipments are delivered to the transportation company in good condition. Architectural Response Kollection, Inc.'s liability ceases at that time. If a shipment is received damaged, you should immediately file a claim with the transportation company. Inspect all cartons upon delivery. Do not destroy packing material until shipment has been inspected. Then proceed to file a claim with the carrier.

CONCEALED DAMAGE & SHORTAGES

Customers are protected from concealed damage and shortages if they file claims with the carrier within five days of delivery. Architectural Response Kollection, Inc. suggests the words "subject to inspection" accompany signature if goods are crated or cartoned and thus cannot be examined at time of receipt. Any claims for shipping damage must be filed by the customer with the carrier within five days of receipt.

REPAIR CHARGES

Prior written approval is required for repairs of merchandise charged to Architectural Response Kollection, Inc. Failure to do so will result in customer funded repairs. Merchandise may not be returned without our prior written authorization along with shipping instructions. Unauthorized returns will not be accepted and will be returned freight collect.

All merchandise being returned must be properly packed and protected to ensure no further damage is incurred during transportation back to Architectural Response Kollection, Inc.'s facility. Upon receipt all returned merchandise will be thoroughly inspected and the results compared to the reason for return stated on RGA. Any discrepancies, such as additional damage, signs of usage, missing parts etc., will result in an adjustment to the amount of credit issued.

WARRANTY

Architectural Response Kollection, Inc. products are manufactured according to our high standards for fine quality materials and workmanship. We warrant all standard catalog items against failure due to defective materials or workmanship for a period of ten years of single shift service from the date of shipment.

This warranty is applicable only if furniture is properly installed and maintained in an office environment. This warranty does not apply to damages, neglect, misused or altered products, nor defects in materials not manufactured by Architectural Response Kollection, Inc. Excluded from this warranty are leathers, marble, Corian and hard surfaces.

During this warranty period, Architectural Response Kollection Inc.'s sole obligation is to repair or replace at Architectural Response Kollection, Inc.'s discretion, products which prove to be defective during the warranty period.

Architectural Response Kollection, Inc. extends no other warranties, expressed or implied including warranty of merchantability or fitness for a particular purpose. Architectural Response Kollection, Inc. shall not be liable for loss of time, inconvenience, commercial loss, incidental or consequential damages.

STANDARD FEATURES

LOCKS
Standard on all drawer pedestals.
Brushed nickel finish.

PULLS
Standard on all drawers and doors except overhead storage doors.
Brushed nickel finish.

BOX DRAWERS
Top box drawer has one pencil tray.
All box drawers have one fully adjustable divider.

TACK PANEL FABRIC SELECTIONS
Due to fabric manufacturers ongoing fabric additions, color and material changes, all of Architectural Response Kollection, Inc. fabrics are COM.
*Please contact fabric manufacturer for sampling support.

MATERIALS

The first step towards building a quality piece of furniture lies in obtaining the finest materials. Architectural Response Kollection, Inc. has one of the most stringent veneer and hardwood grading standards in the industry.

These fine materials are finished with a highly durable conversion varnish system.

STANDARD FINISHES

*Please see Architectural Response Kollection, Inc. website for standard finishes.

Other wood species available.
Call factory for pricing.
Contact information Tel. 714.241.7100
Toll-free 888.241.7100.

COLOR & GRAIN MATCHING

Different wood species offer unique texture and grain. Variations in finish color and value may occur due to the natural characteristics of wood. Architectural Response Kollection, Inc. carefully selects all materials used in every product to minimize the natural variation in materials. Each color match sample submitted and the furniture you receive may not be an exact match.

When re-ordering furniture for an existing project, where color change has occurred as a natural part of the aging process, please provide sample if color matching is critical.

FABRIC COM

COM is Customer's Own Material. Customer must take full responsibility for selecting, purchasing and shipping COM to Architectural Response Kollection, Inc. All shipments must be clearly marked with the customer's name and customer order number.

A sample must first be sent for Architectural Response Kollection, Inc.'s approval as to whether or not it can be applied on our product.

Your order should indicate which side of the material is to be exposed and if special application instructions apply. Specify the supplier's name, material number and description. If the fabric is a stripe or pattern, specify vertical or horizontal application. In the absence of instructions, Architectural Response Kollection, Inc. will determine the appropriate application.

Yardage requirements shown in the price list assume 60" wide plain fabric.

CARE & MAINTENANCE

WOOD FINISHES
When cleaning wood, use a soft cotton cloth moistened with a mild soap and warm water solution and dry immediately. Architectural Response Kollection, Inc. does not recommend the use of waxes or polish.

In some cases, the rubber support feet used on the bottom of common office equipment (teleconferencing phones, laptops, microphones, copiers, etc.) can create unsightly marks on the surface of wood tops, due to oxidation of the lacquer finish. We suggest these machines be placed on a protective type of padding, such as felt.

STONE & SOLID SURFACE MATERIAL
Despite its reputation for durability, natural stone can easily be broken during handling and/or installation if proper techniques are not followed. Architectural Response Kollection, Inc. is not responsible for the installation of natural stone or solid surface materials on its products. Therefore, installers specially trained in the installation of these materials must be utilized to ensure a quality installation.

Architectural Response Kollection, Inc. shall not be liable for any damages incurred during the handling and/or installation of natural stone or solid surface materials on its products.

TYPICAL CONFIGURATIONS

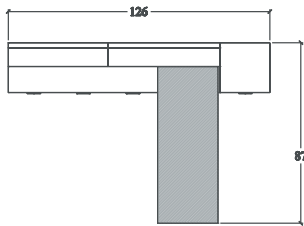
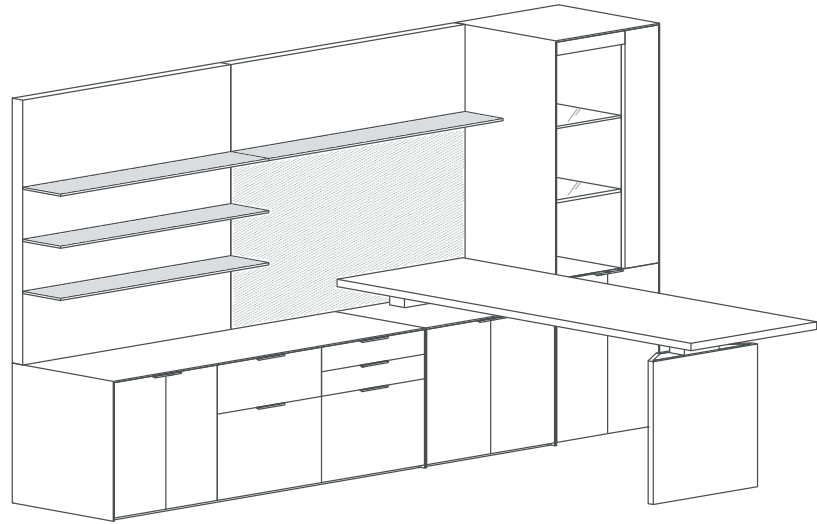

MODEL NUMBER	DESCRIPTION	MATERIAL	PRICE
E/AROD-3084	ASIST Height Adjustable Run Off Desk	Veneer	5925
E/CRC-2430-24	Credenza Case	Veneer	1950
E/ACRC-2430-CS	ASIST Height Adjustable Component Closed Storage	Veneer	3300
E/CRC-2472-24	Credenza Case	Veneer	3400
E/CRC-2424-24-BBF	Box / Box / File Component	Veneer	2050
E/CRC-2424-24-BF	Box / File Component	Veneer	1725
E/CRC-2424-24-CS	Closed Storage Component	Veneer	1450
E/WP-5442 FP MS-1	Wall Panel with Tackable Fabric Surface & (1) Metal Shelf	Veneer/Fabric/Metal	2475
E/WP-4842 MS-3	Wall Panel (3) Metal Shelves	Veneer/Metal	2350
E/TW-2472-ODSW	Open Display Storage Wardrobe Tower	Veneer	5700
TOTAL			\$30,325

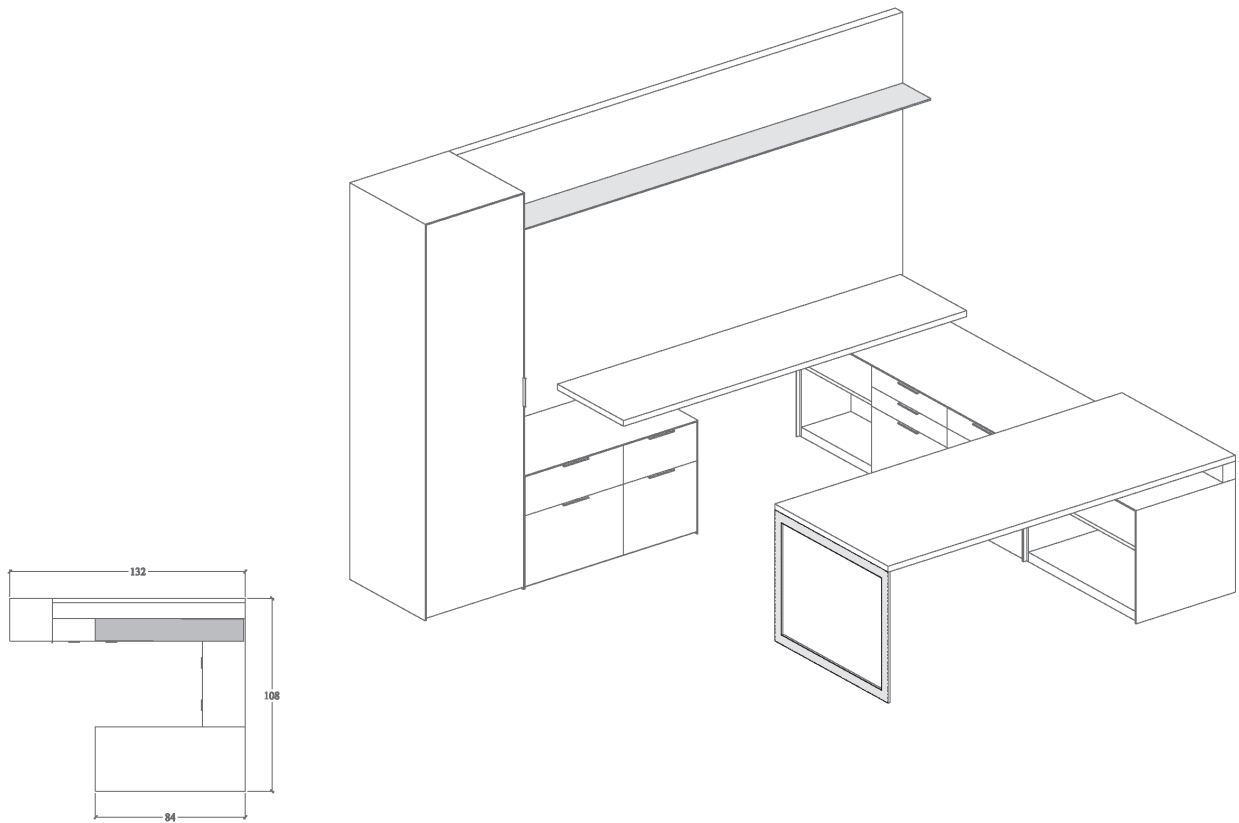

MODEL NUMBER	DESCRIPTION	MATERIAL	PRICE
E/WS-3684	Desk Worksurface	Veneer	2600
E/OL-36-28	Metal O-Leg	Veneer	1350
E/R-36	Riser	Veneer	150
E/CRC-24108-24	Low Credenza Case	Veneer	4725
E/ACRC-2424-24-OS	ASIST Open Storage Component	Veneer	2675
E/CRC-2424-24-BBF	Box / Box / File Component	Veneer	2050
E/CRC-2424-24-BBF	Box / Box / File Component	Veneer	2050
E/CRC-2436-24-OS	Open Storage Component	Veneer	1100
E/WS-2484	Credenza Worksurface	Veneer	1875
E/CRC-2448-24	Low Credenza Case	Veneer	2625
E/ACRC-2418-24-BF	ASIST Box / File Component	Veneer	3000
E/CRC-2430-24-BF	Box / File Component	Veneer	1825
E/WP-11454 FP MS-1	Wall Panel Fabric Panel & (1) Metal Shelf	Veneer/Metal	6950
E/TW-2484 CS	Closed Storage Tower	Veneer	6325
TOTAL			\$39,300

TYPICAL CONFIGURATIONS

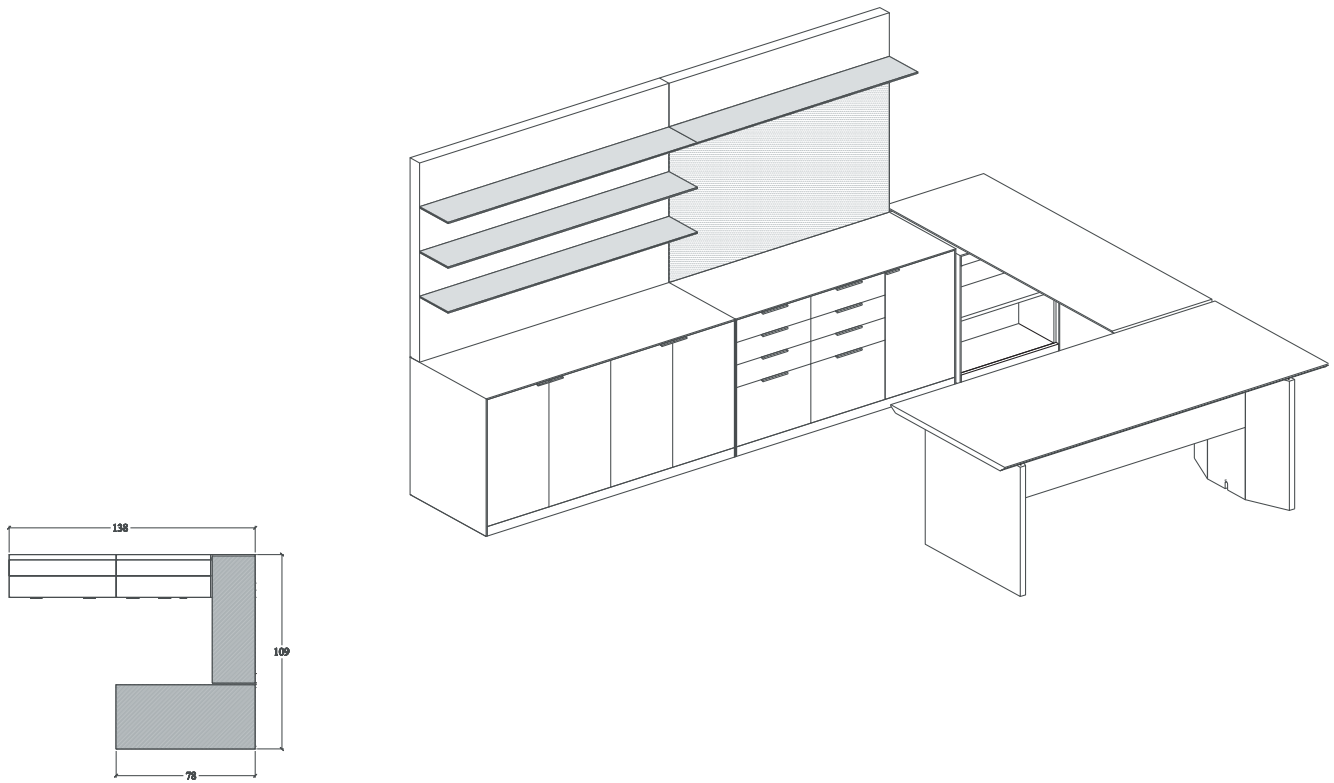

MODEL NUMBER	DESCRIPTION	MATERIAL	PRICE
E/ATD-3678	ASIST Height Adjustable Desk & Partial Modesty	Veneer	8675
E/BT-2472	Bridge Top	Veneer	1600
E/ACRC-2424-OS	ASIST Height Adjustable Component Open with Shelf	Veneer	2675
E/AFP-2415-24-(SFP)	ASIST Faceted Panel (Single Facet Panel)	Veneer	1500
E/CR-2454-29	High Fixed Credenza Case	Veneer	8775
E/CRC-2418-28-CS	Closed Storage Component	Veneer	1400
E/CRC-2418-28-BBF	Box / Box / File Component	Veneer	2100
E/CRC-2418-28-BBF	Box / Box / File Component	Veneer	2100
E/CR-2460-29	High Fixed Credenza Case	Veneer	3300
E/CRC-2430-28-CS	Closed Storage Component	Veneer	1950
E/CRC-2430-28-CS	Closed Storage Component	Veneer	1950
E/WP-5442-FP MS-1	Wall Panel with Tackable Fabric Surface & (1) Metal Shelf	Veneer/Fabric/Metal	2475
E/WP-6042 MS-3	Wall Panel with (3) Metal Shelves	Veneer/Metal	3100
TOTAL			\$41,600

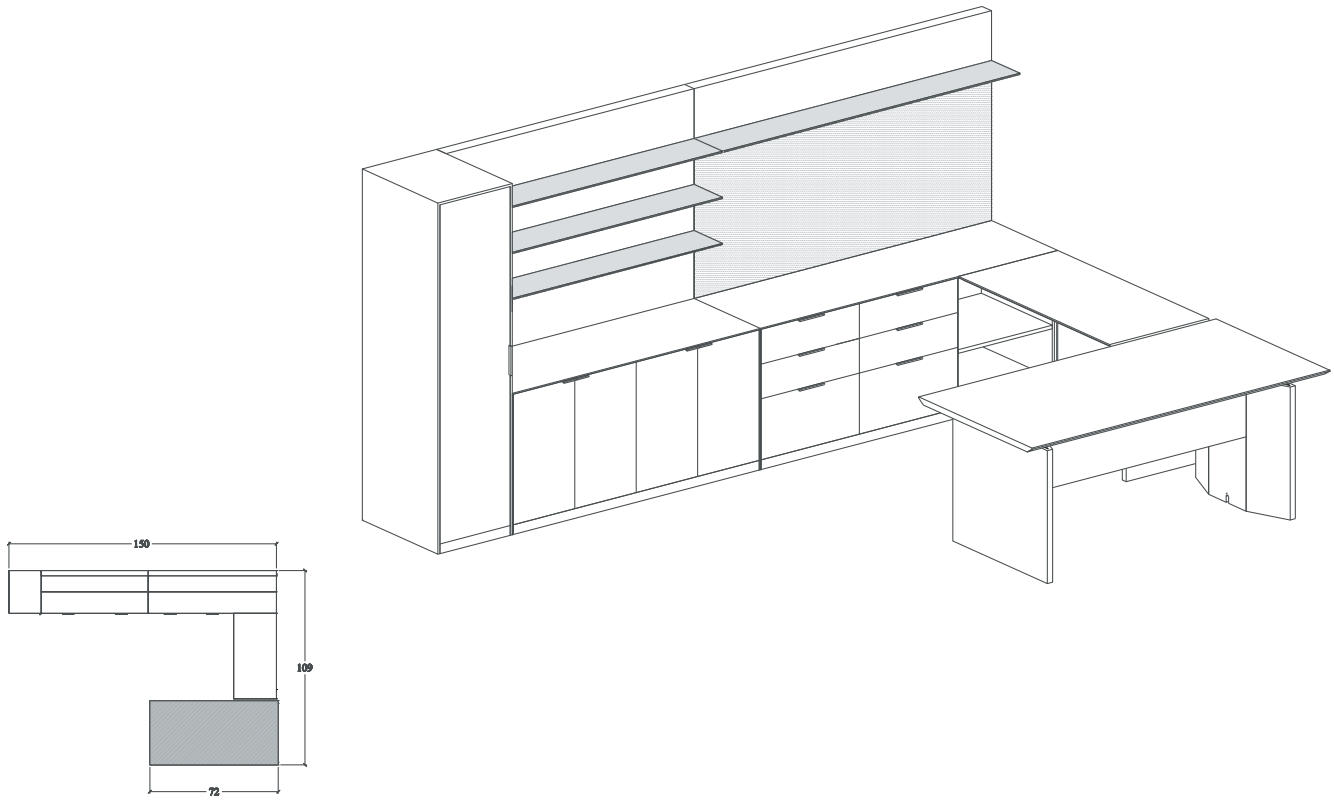

MODEL NUMBER	DESCRIPTION	MATERIAL	PRICE
E/ATD-3678	ASIST Height Adjustable Desk & Partial Modesty	Veneer	8675
E/BT-2448	Bridge Top	Veneer	1100
E/ABP-16-28 (R)	ASIST Bridge End Panel-Specify (L) Left or (R) Right	Veneer	1475
E/CR-2472-29	High Fixed Credenza Case	Veneer	8775
E/CRC-2424-28-OS	Open Storage Component	Veneer	1025
E/CRC-2424-28-BBF	Box / Box / File Component	Veneer	2275
E/CRC-2424-28-BBF	Box / Box / File Component	Veneer	2275
E/CR-2460-29 (2)-30 CS	High Fixed Credenza Case	Veneer	3800
E/CRC-2430-28-CS	Closed Storage Component	Veneer	1950
E/CRC-2430-28-CS	Closed Storage Component	Veneer	1950
E/WP-7242 FP MS-1	Wall Panel with Tackable Fabric Surface & (1) Metal Shelf	Veneer/Fabric/Metal	3275
E/WP-6042 MS-3	Wall Panel with (3) Metal Shelves	Veneer/Metal	3100
E/TW-1872-CS	Closed Storage Tower	Veneer	4575
TOTAL			\$44,250

TYPICAL CONFIGURATIONS

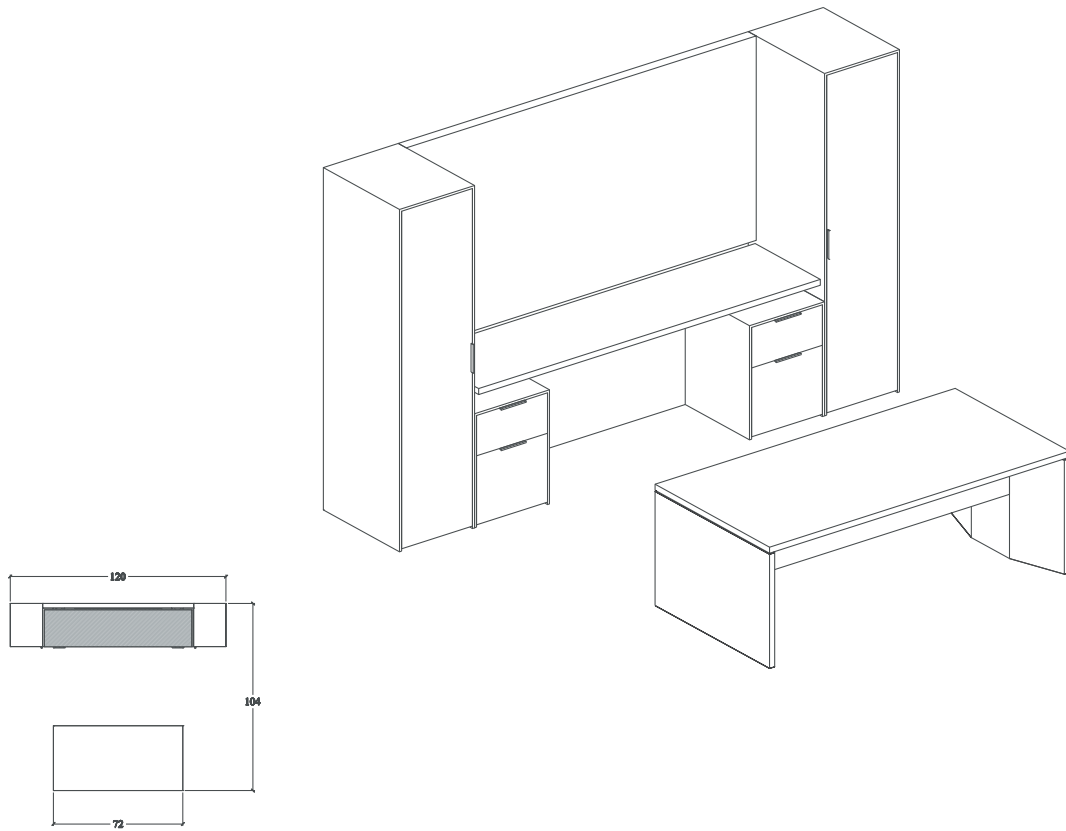

MODEL NUMBER	DESCRIPTION	MATERIAL	PRICE
E/TD-3672	Table Desk with 12" Modesty Panel	Veneer	6225
E/TW-1872-CS	Closed Storage Tower	Veneer	4575
E/WS-2484	Work Surface	Veneer	1875
E/ACRC-2418-24-BF	ASIST Height Adjustable Box / File Component	Veneer	3000
E/AP-48	Access Panel	Veneer	850
E/ACRC-2418-24-BF	ASIST Height Adjustable Box / File Component	Veneer	3000
E/WP-8442	Wall Panel-Wood	Veneer	2450
E/TW-1872-CS	Closed Storage Tower	Veneer	4575
TOTAL			\$26,550

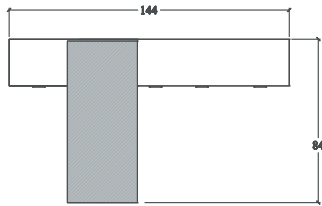
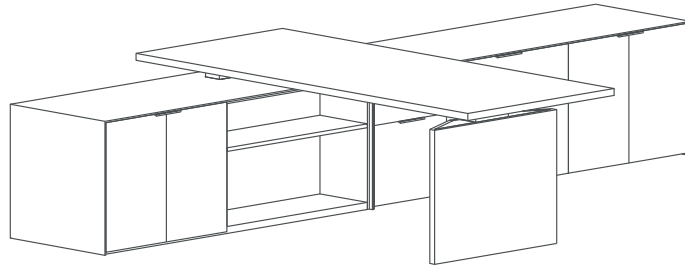

MODEL NUMBER	DESCRIPTION	MATERIAL	PRICE
E/CRC-2466-24	Low Credenza Case	Veneer	3175
E/CRC-2430-24-CS	Low Closed Storage Component	Veneer	1775
E/ACRC-2436-OS	ASIST Height Adjustable Component Open Storage	Veneer	3225
E/AROD-3684	ASIST Height Adjustable Run Off Desk	Veneer	5925
E/CRC-2478-24	Low Credenza Case	Veneer	3625
E/CRC-2418-24-BBF	Low Box / Box / File Component	Veneer	1950
E/CRC-2430-24-BF	Low Box / File Component	Veneer	1825
E/CRC-2430-24-CS	Low Closed Storage Component	Veneer	1775
TOTAL			\$23,275

FIXED DESKS

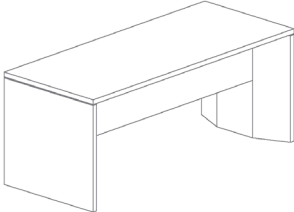
FIXED TABLE DESK	MODEL NUMBER	DIMENSIONS			PRICE VENEER
		D	W	H	
	30" DEEP				
	E/TD-3066	30	66	29	5350
	E/TD-3072	30	72	29	5575
	E/TD-3078	30	78	29	5800
	E/TD-3084	30	84	29	6025
	36" DEEP				
	E/TD-3666	36	66	29	5975
	E/TD-3672	36	72	29	6225
	E/TD-3678	36	78	29	6475
	E/TD-3684	36	84	29	6725

FIXED PENNISULA DESK	MODEL NUMBER	DIMENSIONS			PRICE VENEER
		D	W	H	
	36" DEEP				
	E/PD-3666	36	66	29	5250
	E/PD-3672	36	72	29	5625
	E/PD-3678	36	78	29	5975
	E/PD-3684	36	84	29	6350

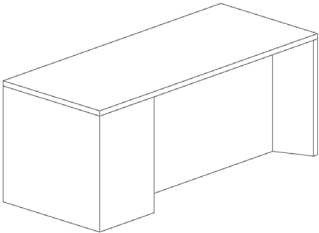
FIXED SINGLE PEDESTAL DESK	MODEL NUMBER	DIMENSIONS			PRICE VENEER
		D	W	H	
	30" DEEP				
	E/SP-3066	30	66	29	6250
	E/SP-3072	30	72	29	6500
	E/SP-3078	30	78	29	6725
	E/SP-3084	30	84	29	6975
	36" DEEP				
	E/SP-3666	36	66	29	6675
	E/SP-3672	36	72	29	6925
	E/SP-3678	36	78	29	7200
	E/SP-3684	36	84	29	7450

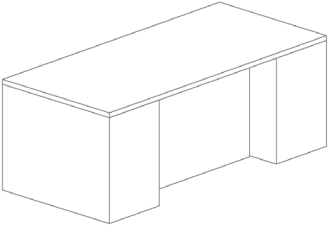
FIXED DOUBLE PEDESTAL DESK	MODEL NUMBER	DIMENSIONS			PRICE VENEER
		D	W	H	
	30" DEEP				
	E/DP-3066	30	66	29	8475
	E/DP-3072	30	72	29	8700
	E/DP-3078	30	78	29	8950
	E/DP-3084	30	84	29	9175
	36" DEEP				
	E/DP-3666	36	66	29	8750
	E/DP-3672	36	72	29	9000
	E/DP-3678	36	78	29	9275
	E/DP-3684	36	84	29	9525

FIXED WORKSURFACES

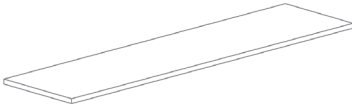

DESK WORKSURFACE	MODEL NUMBER	DIMENSIONS			PRICE VENEER
		D	W	H	
	30" DEEP				
	E/WT-3060	30	60	1 1/4	1650
	E/WT-3066	30	66	1 1/4	1800
	E/WT-3072	30	72	1 1/4	1950
	E/WT-3078	30	78	1 1/4	2100
	E/WT-3084	30	84	1 1/4	2250
	36" DEEP				
	E/WT-3660	36	60	1 1/4	1925
	E/WT-3666	36	66	1 1/4	2075
	E/WT-3672	36	72	1 1/4	2250
E/WT-3678	36	78	1 1/4	2425	
E/WT-3684	36	84	1 1/4	2600	

FIXED 24" DEEP WORKSURFACE

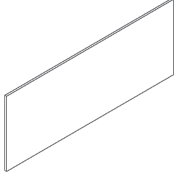
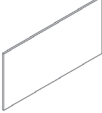

	E/WS-2418	24	18	1 1/4	500
	E/WS-2424	24	24	1 1/4	625
	E/WS-2430	24	30	1 1/4	750
	E/WS-2436	24	36	1 1/4	875
	E/WS-2442	24	42	1 1/4	1000
	E/WS-2448	24	48	1 1/4	1125
	E/WS-2454	24	54	1 1/4	1250
	E/WS-2460	24	60	1 1/4	1375
	E/WS-2466	24	66	1 1/4	1500
	E/WS-2472	24	72	1 1/4	1625
	E/WS-2478	24	78	1 1/4	1750
	E/WS-2484	24	84	1 1/4	1875
	E/WS-2490	24	90	1 1/4	2000
	E/WS-2496	24	96	1 1/4	2125
	E/WS-24102	24	102	1 1/4	2250
	E/WS-24108	24	108	1 1/4	2375
	E/WS-24114	24	114	1 1/4	2500
	E/WS-24120	24	120	1 1/4	2625
	E/WS-24126	24	126	1 1/4	2750
	E/WS-24132	24	132	1 1/4	2875
E/WS-24138	24	138	1 1/4	3000	
E/WS-24144	24	144	1 1/4	3125	

FIXED 24" DEEP BRIDGE WORKSURFACE	MODEL NUMBER	DIMENSIONS			PRICE VENEER
		D	W	H	
	E/BT-2442	24	42	1 1/4	1000
	E/BT-2448	24	48	1 1/4	1100
	E/BT-2454	24	54	1 1/4	1225
	E/BT-2460	24	60	1 1/4	1375
	E/BT-2466	24	66	1 1/4	1475
	E/BT-2472	24	72	1 1/4	1600
	E/BT-2478	24	78	1 1/4	1725
	E/BT-2484	24	84	1 1/4	1850

FIXED BRIDGE END PANEL	MODEL NUMBER	D	W	H	PRICE VENEER
	E/EP-2424	5	24	27 3/4	1475

FIXED DESK MODESTY PANEL	MODEL NUMBER	D	W	H	PRICE VENEER
	FULL WIDTH / FULL HEIGHT				
	E/MP-6028	3/4	60	27 3/4	1050
	E/MP-6628	3/4	66	27 3/4	1150
	E/MP-7228	3/4	72	27 3/4	1250
	E/MP-7828	3/4	78	27 3/4	1375
E/MP-8428	3/4	84	27 3/4	1475	
	PARTIAL WIDTH / FULL HEIGHT				
	E/MP-60/50-28	3/4	50	27 3/4	875
	E/MP-66/56-28	3/4	56	27 3/4	975
	E/MP-72/62-28	3/4	62	27 3/4	1075
	E/MP-78/68-28	3/4	68	27 3/4	1200
E/MP-84/74-28	3/4	74	27 3/4	1300	
	PARTIAL WIDTH / PARTIAL HEIGHT				
	E/MP-60/50-12	3/4	50	12	675
	E/MP-66/56-12	3/4	56	12	750
	E/MP-72/62-12	3/4	62	12	825
	E/MP-78/68-12	3/4	68	12	900
E/MP-84/74-12	3/4	74	12	975	

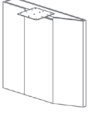
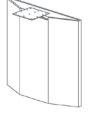
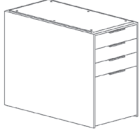
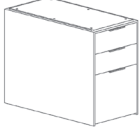
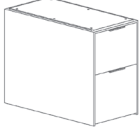
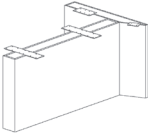
FIXED SUPPORTS

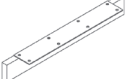
FIXED DESK SUPPORTS	MODEL NUMBER	DIMENSIONS			PRICE VENEER
		D	W	H	
	END PANEL				
	E/EP-30-28	30	5	27 3/4	700
	E/EP-36-28	36	5	27 3/4	825
	FACETED PANEL				
	E/FP MS 2L-30-28	30	5	27 3/4	1400
	E/FP MS 2L-36-28	36	5	27 3/4	1575
	DRAWER PEDESTAL				
	E/BBBF-3018-28	30	18	27 3/4	3075
	E/BBBF-3618-28	36	18	27 3/4	3300
	DRAWER PEDESTAL				
	E/BBF-3018-28	30	18	27 3/4	2850
	E/BBF-3618-28	36	18	27 3/4	3075
	DRAWER PEDESTAL				
	E/FF-3018-28	30	18	27 3/4	2725
	E/FF-3618-28	36	18	27 3/4	2950
	PENINSULA SUPPORT				
	E/PS-3666-28	36	66	27 3/4	3000
	E/PS-3672-28	36	72	27 3/4	3025
	E/PS-3678-28	36	78	27 3/4	3125
	E/PS-3684-28	36	84	27 3/4	3300
	OPEN STORAGE				
	E/OS-2430-28	24	30	27 3/4	2300
	E/OS-2436-28	24	36	27 3/4	2450
	RISER				
	E/R-30	1 1/4	30	5	125
	E/R-36	1 1/4	36	5	150

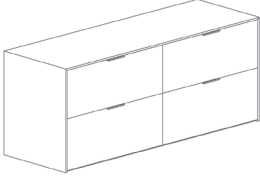
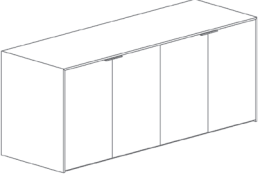
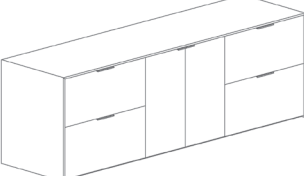

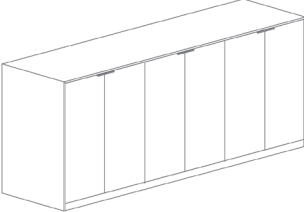
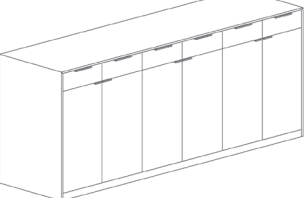

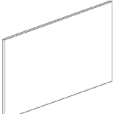
FIXED 29" HEIGHT CREDENZA	MODEL NUMBER	DIMENSIONS			PRICE VENEER
		D	W	H	
	E/CR-2460-2-30FF	24	60	29	5675
	E/CR-2472-2-36FF	24	72	29	6325
	E/CR-2490-3-30FF	24	90	29	8450
	E/CR-24108-3-36FF	24	108	29	9425
	E/CR-2460-2-30CS	24	60	29	5275
	E/CR-2472-2-36CS	24	72	29	6275
	E/CR-2490-3-30CS	24	90	29	7850
	E/CR-24108-3-36CS	24	108	29	9350
	E/CR-2490-1-30FF/1-30ST/1-30FF	24	90	29	8250
	E/CR-24108-1-36FF/1-36ST/1-36FF	24	108	29	9400

36" HEIGHT BUFFET CREDENZA					
	BUFFET WITHOUT DRAWERS				
	E/CR-6024-36-B	24	60	36	6850
	E/CR-7224-36-B	24	72	36	7500
	E/CR-8424-36-B	24	84	36	8125
	E/CR-9024-36-B	24	90	36	8400
	BUFFET WITH DRAWERS				
	E/CR-6024-36-B-D	24	60	36	8125
	E/CR-7224-36-B-D	24	72	36	8900
	E/CR-8424-36-B-D	24	84	36	9625
	E/CR-9024-36-B-D	24	90	36	10850

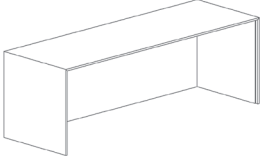



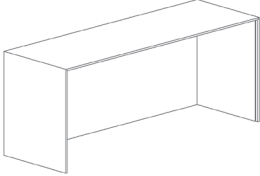

CREDENZA ACCESS PANEL					
	E/RBP-30	3/4	30	27 3/4	525
	E/RBP-36	3/4	36	27 3/4	625
	E/RBP-42	3/4	42	27 3/4	750
	E/RBP-48	3/4	48	27 3/4	850
	E/RBP-54	3/4	54	27 3/4	950
	E/RBP-60	3/4	60	27 3/4	1050
	E/RBP-66	3/4	66	27 3/4	1150
	E/RBP-72	3/4	72	27 3/4	1250

FIXED CREDENZAS

FIXED 24" HEIGHT CREDENZA CASE	MODEL NUMBER	DIMENSIONS			PRICE VENEER
		D	W	H	
	E/CR-2418-24	24	18	24	1500
	E/CR-2424-24	24	24	24	1725
	E/CR-2430-24	24	30	24	1950
	E/CR-2436-24	24	36	24	2225
	E/CR-2442-24	24	42	24	2400
	E/CR-2448-24	24	48	24	2625
	E/CR-2454-24	24	54	24	2850
	E/CR-2460-24	24	60	24	2950
	E/CR-2466-24	24	66	24	3175
	E/CR-2472-24	24	72	24	3400
	E/CR-2478-24	24	78	24	3625
	E/CR-2484-24	24	84	24	3850
	E/CR-2490-24	24	90	24	4075
	E/CR-2496-24	24	96	24	4350
	E/CR-24102-24	24	102	24	4450
	E/CR-24108-24	24	108	24	4725
E/CR-24114-24	24	114	24	4900	
E/CR-24120-24	24	120	24	5125	

FIXED 24" HEIGHT CREDENZA COMPONENTS					
	BOX / BOX / FILE PEDESTAL				
	E/CRC-2418-24-BBF	24	18	24	1950
	E/CRC-2424-24-BBF	24	24	24	2050
	E/CRC-2430-24-BBF	24	30	24	2275
E/CRC-2436-24-BBF	24	36	24	2250	
	BOX / FILE PEDESTAL				
	E/CRC-2418-24-BF	24	18	24	1675
	E/CRC-2424-24-BF	24	24	24	1725
	E/CRC-2430-24-BF	24	30	24	1825
E/CRC-2436-24-BF	24	36	24	1975	
	CLOSED STORAGE PEDESTAL				
	E/CRC-2418-24-CS	24	18	24	1250
	E/CRC-2424-24-CS	24	24	24	1450
	E/CRC-2430-24-CS	24	30	24	1775
E/CRC-2436-24-CS	24	36	24	2125	
	OPEN STORAGE PEDESTAL				
	E/CRC-2418-24-OS	24	18	24	825
	E/CRC-2424-24-OS	24	24	24	925
	E/CRC-2430-24-OS	24	30	24	1025
E/CRC-2436-24-OS	24	36	24	1100	
	TRASH/RECYCLE PEDESTAL				
	E/CRC-2418-24-TR	24	18	24	1800
E/CRC-2424-24-TR	24	24	24	1875	

FIXED 29" HEIGHT CREDENZA CASE	MODEL NUMBER	DIMENSIONS			PRICE VENEER
		D	W	H	
	E/CR-2418-29	24	18	29	1725
	E/CR-2424-29	24	24	29	2000
	E/CR-2430-29	24	30	29	2300
	E/CR-2436-29	24	36	29	2500
	E/CR-2442-29	24	42	29	2725
	E/CR-2448-29	24	48	29	2950
	E/CR-2454-29	24	54	29	3175
	E/CR-2460-29	24	60	29	3300
	E/CR-2466-29	24	66	29	3575
	E/CR-2472-29	24	72	29	3800
	E/CR-2478-29	24	78	29	4000
	E/CR-2484-29	24	84	29	4225
	E/CR-2490-29	24	90	29	4450
	E/CR-2496-29	24	96	29	4725
	E/CR-24102-29	24	102	29	4950
	E/CR-24108-29	24	108	29	5125
E/CR-24114-29	24	114	29	5400	
E/CR-24120-29	24	120	29	5450	

FIXED 28" HEIGHT CREDENZA COMPONENTS					
	BOX / BOX / FILE PEDESTAL				
	E/CRC-2418-28-BBF	24	18	28	2100
	E/CRC-2424-28-BBF	24	24	28	2275
	E/CRC-2430-28-BBF	24	30	28	2325
	E/CRC-2436-28-BBF	24	36	28	2475
	FILE / FILE PEDESTAL				
	E/CRC-2418-28-FF	24	18	28	1900
	E/CRC-2424-28-FF	24	24	28	2025
	E/CRC-2430-28-FF	24	30	28	2150
	E/CRC-2436-28-FF	24	36	28	2350
	CLOSED STORAGE PEDESTAL				
	E/CRC-2418-28-CS	24	18	28	1400
	E/CRC-2424-28-CS	24	24	28	1600
	E/CRC-2430-28-CS	24	30	28	1950
	E/CRC-2436-28-CS	24	36	28	2325
	OPEN STORAGE PEDESTAL				
	E/CRC-2418-28-OS	24	18	28	925
	E/CRC-2424-28-OS	24	24	28	1025
	E/CRC-2430-28-OS	24	30	28	1100
	E/CRC-2436-28-OS	24	36	28	1200
	PRINTER PEDESTAL				
	E/CRC-2424-28-PR	24	24	28	2075
	TRASH/RECYCLE PEDESTAL				
	E/CRC-2418-28-TR	24	18	28	1925
E/CRC-2424-28-TR	24	24	28	2025	

ASIST DESKS

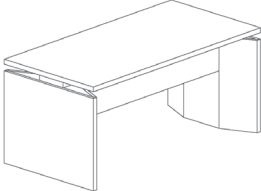
ASIST TABLE DESK	MODEL NUMBER	DIMENSIONS			PRICE VENEER
		D	W	H	
	30" DEEP				
	E/ATD-3060	30	60	29	6000
	E/ATD-3066	30	66	29	7700
	E/ATD-3072	30	72	29	7875
	E/ATD-3078	30	78	29	8000
	E/ATD-3084	30	84	29	8125
	36" DEEP				
	E/ATD-3660	36	60	29	8075
	E/ATD-3666	36	66	29	8275
	E/ATD-3672	36	72	29	8475
	E/ATD-3678	36	78	29	8675
	E/ATD-3684	36	84	29	8875

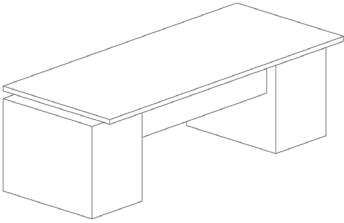

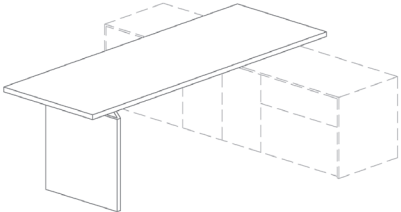
ASIST DOUBLE PEDESTAL DESK	MODEL NUMBER	DIMENSIONS			PRICE VENEER
		D	W	H	
	30" DEEP				
	E/ADP-3066-(BF/BF)	30	66	29	10100
	E/ADP-3072-(BF/BF)	30	72	29	10350
	E/ADP-3078-(BF/BF)	30	78	29	10625
	E/ADP-3084-(BF/BF)	30	84	29	10875
	36" DEEP				
	E/ADP-3666-(BF/BF)	36	66	29	10825
	E/ADP-3672-(BF/BF)	36	72	29	11100
	E/ADP-3678-(BF/BF)	36	78	29	11400
	E/ADP-3684-(BF/BF)	36	84	29	11675

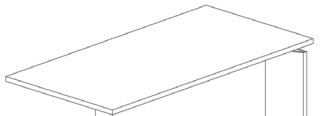
ASIST RUN OFF DESK	MODEL NUMBER Specify (L)eft or (R)ight	DIMENSIONS			PRICE VENEER
		D	W	H	
	30" DEEP				
	E/AROD-3066-()	30	66	29	5075
	E/AROD-3072-()	30	72	29	5200
	E/AROD-3078-()	30	78	29	5375
	E/AROD-3084-()	30	84	29	5550
	36" DEEP				
	E/AROD-3666-()	36	66	29	5575
	E/AROD-3672-()	36	72	29	5725
	E/AROD-3678-()	36	78	29	5975
	E/AROD-3684-()	36	84	29	5925

ASIST PENNISULA DESK		DIMENSIONS			PRICE
	36" DEEP				
	E/APD-3666-()	36	66	29	6100
	E/APD-3672-()	36	72	29	6400
	E/APD-3678-()	36	78	29	6675
	E/APD-3684-()	36	84	29	6975

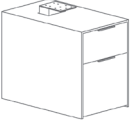
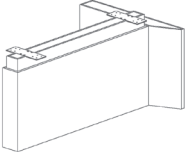
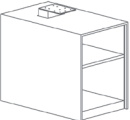
ASIST SUPPORTS

ASIST DESK SUPPORTS	MODEL NUMBER	DIMENSIONS			PRICE VENEER
		D	W	H	
	FACETED PANEL				
	E/AFP-530-24	30	5	24	1750
	E/AFP-536-24	36	5	24	1900
	BOX / FILE PEDESTAL				
	E/ABF-1824-24	24	18	24	3575
	E/ABF-1830-24	30	18	24	3800
	PENINSULA SUPPORT				
	E/APS-3660-24	36	60	24	4050
	E/APS-3666-24	36	66	24	4200
	E/APS-3672-24	36	72	24	4325
	E/APS-3678-24	36	78	24	4475
	E/APS-3684-24	36	84	24	4600
	OPEN STORAGE LIFT				
	E/AOS-1830-24	30	18	24	3050
	E/AOS-1836-24	36	18	24	3325

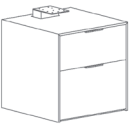
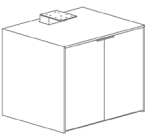
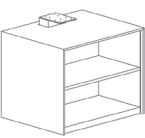
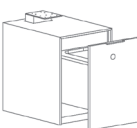
ASIST 24" HEIGHT CREENZA COMPONENTS	MODEL NUMBER	DIMENSIONS			PRICE VENEER
		D	W	H	
	FACETED PANEL E/AFP-524-24	24	5	24	1600
	FACETED PANEL E/ABP-516-24	16	5	24	1500
	BOX / BOX / FILE PEDESTAL E/ACRC-2418-24-BBF	24	18	24	3250
	E/ACRC-2424-24-BBF	24	24	24	3600
	E/ACRC-2430-24-BBF	24	30	24	4300
	E/ACRC-2436-24-BBF	24	36	24	4725
	BOX / FILE PEDESTAL E/ACRC-2418-24-BF	24	18	24	3000
	E/ACRC-2424-24-BF	24	24	24	3350
	E/ACRC-2430-24-BF	24	30	24	4025
	E/ACRC-2436-24-BF	24	36	24	4425
	CLOSED STORAGE PEDESTAL E/ACRC-2418-24-CS	24	18	24	2750
	E/ACRC-2424-24-CS	24	24	24	2950
	E/ACRC-2430-24-CS	24	30	24	3300
	E/ACRC-2436-24-CS	24	36	24	3625
	OPEN STORAGE PEDESTAL E/ACRC-2418-24-OS	24	18	24	2400
	E/ACRC-2424-24-OS	24	24	24	2675
	E/ACRC-2430-24-OS	24	30	24	2950
	E/ACRC-2436-24-OS	24	36	24	3225
	TRASH/RECYCLE PEDESTAL E/ACRC-2418-24-TR	24	18	24	3775
	E/ACRC-2424-24-TR	24	24	24	4125

STORAGE TOWERS

72" HEIGHT

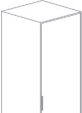
CLOSED STORAGE	MODEL NUMBER	DIMENSIONS			PRICE VENEER
		D	W	H	
	E/TW-1872-CS	24	18	72	4575
	E/TW-2472-CS	24	24	72	5850
	E/TW-3072-CS	24	30	72	6450
	E/TW-3672-CS	24	36	72	7300

CLOSED STORAGE / FILE	MODEL NUMBER	D	W	H	PRICE
	E/TW-1872-CSF	24	18	72	5250
	E/TW-2472-CSF	24	24	72	6425
	E/TW-3072-CSF	24	30	72	7100
	E/TW-3672-CSF	24	36	72	7950

OPEN DISPLAY / FILE	MODEL NUMBER	D	W	H	PRICE
	E/TW-1872-ODF	24	18	72	4925
	E/TW-2472-ODF	24	24	72	5750
	E/TW-3072-ODF	24	30	72	6525
	E/TW-3672-ODF	24	36	72	7350

OPEN DISPLAY / CLOSED STORAGE	MODEL NUMBER	D	W	H	PRICE
	E/TW-1872-ODCS	24	18	72	4325
	E/TW-2472-ODCS	24	24	72	5050
	E/TW-3072-ODCS	24	30	72	5750
	E/TW-3672-ODCS	24	36	72	6475

OPEN DISPLAY / FILE / WARDROBE	MODEL NUMBER	D	W	H	PRICE
	E/TW-2472-ODFW	24	24	72	7025
	E/TW-3072-ODFW	24	30	72	7725
	E/TW-3672-ODFW	24	36	72	8600

OPEN DISPLAY / STORAGE / WARDROBE	MODEL NUMBER	D	W	H	PRICE
	E/TW-2472-ODSW	24	24	72	5700
	E/TW-3072-ODSW	24	30	72	6400
	E/TW-3672-ODSW	24	36	72	7125

84" HEIGHT

CLOSED STORAGE	MODEL NUMBER	DIMENSIONS			PRICE VENEER
		D	W	H	
	E/TW-1884-CS	24	18	84	5350
	E/TW-2484-CS	24	24	84	6325
	E/TW-3084-CS	24	30	84	7525
	E/TW-3684-CS	24	36	84	8575

CLOSED STORAGE / FILE	MODEL NUMBER	D	W	H	PRICE
	E/TW-1884-CSF	24	18	84	6000
	E/TW-2484-CSF	24	24	84	7025
	E/TW-3084-CSF	24	30	84	7950
	E/TW-3684-CSF	24	36	84	8950

OPEN DISPLAY / FILE	MODEL NUMBER	D	W	H	PRICE
	E/TW-1884-ODF	24	18	84	5325
	E/TW-2484-ODF	24	24	84	6175
	E/TW-3084-ODF	24	30	84	6975
	E/TW-3684-ODF	24	36	84	7825

OPEN DISPLAY / CLOSED STORAGE	MODEL NUMBER	D	W	H	PRICE
	E/TW-1884-ODCS	24	18	84	4925
	E/TW-2484-ODCS	24	24	84	5750
	E/TW-3084-ODCS	24	30	84	6575
	E/TW-3684-ODCS	24	36	84	7400

OPEN DISPLAY / FILE / WARDROBE	MODEL NUMBER	D	W	H	PRICE
	E/TW-2484-ODFW	24	24	84	7425
	E/TW-3084-ODFW	24	30	84	8300
	E/TW-3684-ODFW	24	36	84	9225

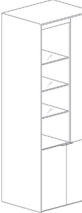
OPEN DISPLAY / STORAGE / WARDROBE	MODEL NUMBER	D	W	H	PRICE
	E/TW-2484-ODSW	24	24	84	7000
	E/TW-3084-ODSW	24	30	84	7775
	E/TW-3684-ODSW	24	36	84	8325

OVERHEAD STORAGE

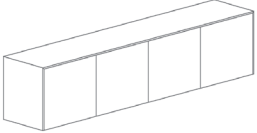
SINGLE OVERHEAD CLOSED STORAGE	MODEL NUMBER	DIMENSIONS			PRICE VENEER
		D	W	H	
	E/OH-3016-C	15	30	16	2550
	E/OH-3616-C	15	36	16	2800
	E/OH-4216-C	15	42	16	3375
	E/OH-4816-C	15	48	16	3650
	E/OH-5416-C	15	54	16	4125
	E/OH-6016-C	15	60	16	4500
	E/OH-6616-C	15	66	16	4775
	E/OH-7216-C	15	72	16	5050
	E/OH-7816-C	15	78	16	5300
	E/OH-8416-C	15	84	16	5775
	E/OH-9016-C	15	90	16	6050
	E/OH-9616-C	15	96	16	6325
	E/OH-10216-C	15	102	16	6600
	E/OH-10816-C	15	108	16	6875

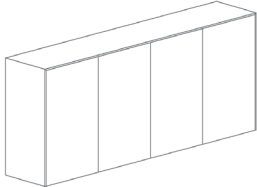
DOUBLE OVERHEAD CLOSED STORAGE	MODEL NUMBER	DIMENSIONS			PRICE VENEER
		D	W	H	
	E/OH-3030-C	15	30	30	3575
	E/OH-3630-C	15	36	30	3975
	E/OH-4230-C	15	42	30	4825
	E/OH-4830-C	15	48	30	5250
	E/OH-5430-C	15	54	30	5650
	E/OH-6030-C	15	60	30	6500
	E/OH-6630-C	15	66	30	6925
	E/OH-7230-C	15	72	30	7325
	E/OH-7830-C	15	78	30	7750
	E/OH-8430-C	15	84	30	9025
	E/OH-9030-C	15	90	30	9450
	E/OH-9630-C	15	96	30	9850
	E/OH-10230-C	15	102	30	10275
	E/OH-10830-C	15	108	30	10675

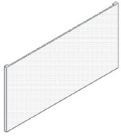
FABRIC TACK PANELS	MODEL NUMBER	DIMENSIONS			PRICE
		D	W	H	
	24" HEIGHT				
	E/FP-2424	2	24	24	300
	E/FP-3024	2	30	24	350
	E/FP-3624	2	36	24	400
	E/FP-4224	2	42	24	450
	E/FP-4824	2	48	24	475
	E/FP-5424	2	54	24	525
	E/FP-6024	2	60	24	575
	E/FP-6624	2	66	24	625
	E/FP-7224	2	72	24	675
	E/FP-7824	2	78	24	700
	E/FP-8424	2	84	24	750
	E/FP-9024	2	90	24	800
	E/FP-9624	2	96	24	850
	E/FP-10224	2	102	24	875
E/FP-10824	2	108	24	925	
E/FP-11424	2	114	24	975	
E/FP-12024	2	120	24	1025	

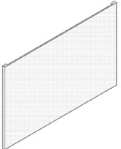
	30" HEIGHT				
	E/FP-2430	2	24	30	325
	E/FP-3030	2	30	30	375
	E/FP-3630	2	36	30	425
	E/FP-4230	2	42	30	450
	E/FP-4830	2	48	30	500
	E/FP-5430	2	54	30	550
	E/FP-6030	2	60	30	600
	E/FP-6630	2	66	30	650
	E/FP-7230	2	72	30	700
	E/FP-7830	2	78	30	750
	E/FP-8430	2	84	30	800
	E/FP-9030	2	90	30	850
	E/FP-9630	2	96	30	875
	E/FP-10230	2	102	30	925
E/FP-10830	2	108	30	975	
E/FP-11430	2	114	30	1025	
E/FP-12030	2	120	30	1075	

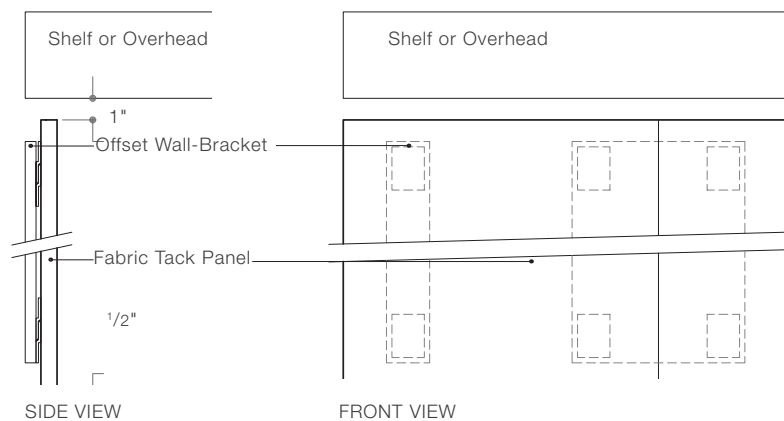

Tackable fabric panels are wall-mounted by means of offset wall-brackets. The appropriate brackets are included with the panel.

TYPICAL WALL PANEL CONFIGURATION

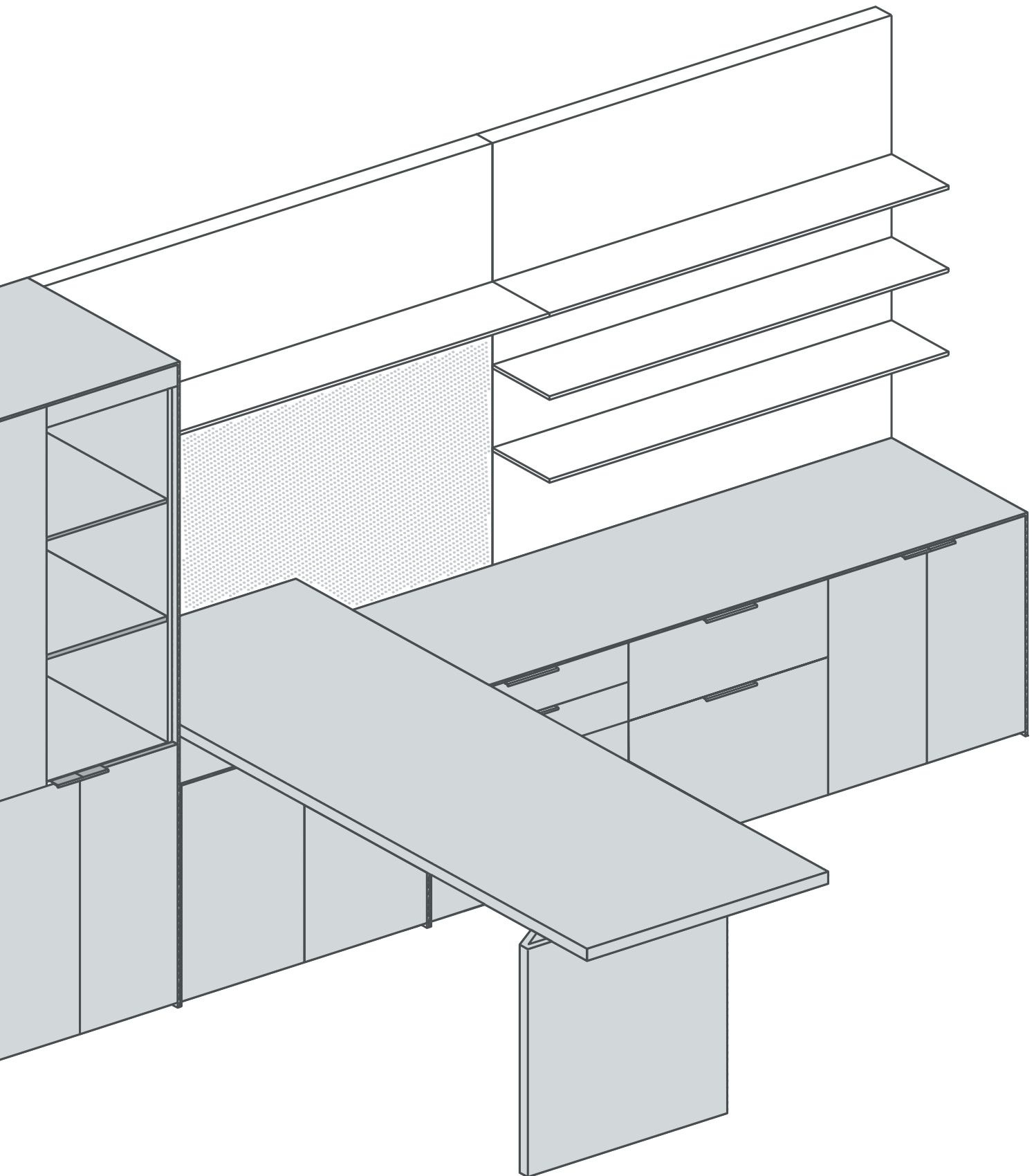

Shown: Wall Panel with Fabric & Shelf, Wall Panel with Shelves*.
*Shelves available in wood, metal and glass.

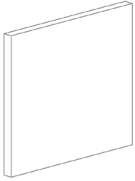
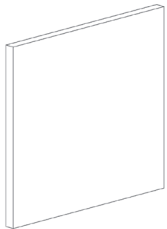
WALL PANELS	MODEL NUMBER	DIMENSIONS			PRICE VENEER/PAINT*
		D	W	H	
	42" HEIGHT				
	E/WP-2442	3	24	42	775
	E/WP-3042	3	30	42	950
	E/WP-3642	3	36	42	1125
	E/WP-4242	3	42	42	1275
	E/WP-4842	3	48	42	1450
	E/WP-5442	3	54	42	1600
	E/WP-6042	3	60	42	1900
	E/WP-6642	3	66	42	1950
	E/WP-7242	3	72	42	2100
	E/WP-7842	3	78	42	2275
	E/WP-8442	3	84	42	2450
	E/WP-9042	3	90	42	2600
	E/WP-9642	3	96	42	2775
	E/WP-10242	3	102	42	2925
E/WP-10842	3	108	42	3100	
E/WP-11442	3	114	42	3275	
E/WP-12042	3	120	42	3425	
	54" HEIGHT				
	E/WP-2454	3	24	54	1075
	E/WP-3054	3	30	54	1450
	E/WP-3654	3	36	54	1700
	E/WP-4254	3	42	54	1975
	E/WP-4854	3	48	54	2225
	E/WP-5454	3	54	54	2500
	E/WP-6054	3	60	54	2750
	E/WP-6654	3	66	54	3000
	E/WP-7254	3	72	54	3275
	E/WP-7854	3	78	54	3525
	E/WP-8454	3	84	54	3775
	E/WP-9054	3	90	54	4050
	E/WP-9654	3	96	54	4300
	E/WP-10254	3	102	54	4575
E/WP-10854	3	108	54	4825	
E/WP-11454	3	114	54	5075	
E/WP-12054	3	120	54	5350	

*Painted finish only available in ARK standard white.

WALL PANEL WOOD SHELVES

42" HEIGHT

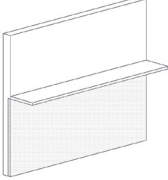
FABRIC PANEL & WOOD SHELF	MODEL NUMBER	DIMENSIONS			PRICE VENEER/PAINT*
		D	W	H	
	E/WP-2442-FP WS-1	3	24	42	1175
	E/WP-3042-FP WS-1	3	30	42	1425
	E/WP-3642-FP WS-1	3	36	42	1675
	E/WP-4242-FP WS-1	3	42	42	1900
	E/WP-4842-FP WS-1	3	48	42	2125
	E/WP-5442-FP WS-1	3	54	42	2350
	E/WP-6042-FP WS-1	3	60	42	2725
	E/WP-6642-FP WS-1	3	66	42	2850
	E/WP-7242-FP WS-1	3	72	42	3075
	E/WP-7842-FP WS-1	3	78	42	3300
	E/WP-8442-FP WS-1	3	84	42	3550
	E/WP-9042-FP WS-1	3	90	42	3775
	E/WP-9642-FP WS-1	3	96	42	4025
	E/WP-10242-FP WS-1	3	102	42	4225
	E/WP-10842-FP WS-1	3	108	42	4475
	E/WP-11442-FP WS-1	3	114	42	4725
E/WP-12042-FP WS-1	3	120	42	4950	

1-WOOD SHELF

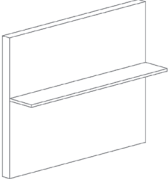
	E/WP-2442 WS-1	3	24	42	875
	E/WP-3042 WS-1	3	30	42	1075
	E/WP-3642 WS-1	3	36	42	1275
	E/WP-4242 WS-1	3	42	42	1450
	E/WP-4842 WS-1	3	48	42	1650
	E/WP-5442 WS-1	3	54	42	1825
	E/WP-6042 WS-1	3	60	42	2150
	E/WP-6642 WS-1	3	66	42	2225
	E/WP-7242 WS-1	3	72	42	2400
	E/WP-7842 WS-1	3	78	42	2600
	E/WP-8442 WS-1	3	84	42	2800
	E/WP-9042 WS-1	3	90	42	2975
	E/WP-9642 WS-1	3	96	42	3175
	E/WP-10242 WS-1	3	102	42	3350
	E/WP-10842 WS-1	3	108	42	3550
	E/WP-11442 WS-1	3	114	42	3750
E/WP-12042 WS-1	3	120	42	3925	

*Painted finish only available in ARK standard white.

WALL PANEL WOOD SHELVES

42" HEIGHT

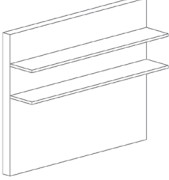
2-WOOD SHELF	MODEL NUMBER	DIMENSIONS			PRICE VENEER/PAINT*
		D	W	H	
	E/WP-2442 WS-2	3	24	42	975
	E/WP-3042 WS-2	3	30	42	1200
	E/WP-3642 WS-2	3	36	42	1425
	E/WP-4242 WS-2	3	42	42	1625
	E/WP-4842 WS-2	3	48	42	1850
	E/WP-5442 WS-2	3	54	42	2050
	E/WP-6042 WS-2	3	60	42	2400
	E/WP-6642 WS-2	3	66	42	2500
	E/WP-7242 WS-2	3	72	42	2700
	E/WP-7842 WS-2	3	78	42	2925
	E/WP-8442 WS-2	3	84	42	3150
	E/WP-9042 WS-2	3	90	42	3350
	E/WP-9642 WS-2	3	96	42	3575
	E/WP-10242 WS-2	3	102	42	3775
	E/WP-10842 WS-2	3	108	42	4000
E/WP-11442 WS-2	3	114	42	4225	
E/WP-12042 WS-2	3	120	42	4425	

3-WOOD SHELF

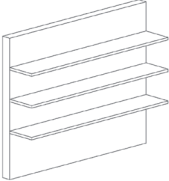
	E/WP-2442 WS-3	3	24	42	1075
	E/WP-3042 WS-3	3	30	42	1325
	E/WP-3642 WS-3	3	36	42	1575
	E/WP-4242 WS-3	3	42	42	1800
	E/WP-4842 WS-3	3	48	42	2050
	E/WP-5442 WS-3	3	54	42	2275
	E/WP-6042 WS-3	3	60	42	2650
	E/WP-6642 WS-3	3	66	42	2775
	E/WP-7242 WS-3	3	72	42	3000
	E/WP-7842 WS-3	3	78	42	3250
	E/WP-8442 WS-3	3	84	42	3500
	E/WP-9042 WS-3	3	90	42	3725
	E/WP-9642 WS-3	3	96	42	3975
	E/WP-10242 WS-3	3	102	42	4200
	E/WP-10842 WS-3	3	108	42	4450
E/WP-11442 WS-3	3	114	42	4700	
E/WP-12042 WS-3	3	120	42	4925	

*Painted finish only available in ARK standard white.

WALL PANEL WOOD SHELVES

54" HEIGHT

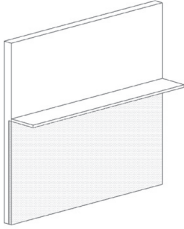
FABRIC PANEL & WOOD SHELF	MODEL NUMBER	DIMENSIONS			PRICE VENEER/PAINT*
		D	W	H	
	E/WP-2454-FP WS-1	3	24	54	1500
	E/WP-3054-FP WS-1	3	30	54	1950
	E/WP-3654-FP WS-1	3	36	54	2275
	E/WP-4254-FP WS-1	3	42	54	2600
	E/WP-4854-FP WS-1	3	48	54	2925
	E/WP-5454-FP WS-1	3	54	54	3275
	E/WP-6054-FP WS-1	3	60	54	3600
	E/WP-6654-FP WS-1	3	66	54	3925
	E/WP-7254-FP WS-1	3	72	54	4275
	E/WP-7854-FP WS-1	3	78	54	4600
	E/WP-8454-FP WS-1	3	84	54	4925
	E/WP-9054-FP WS-1	3	90	54	5275
	E/WP-9654-FP WS-1	3	96	54	5575
	E/WP-10254-FP WS-1	3	102	54	5925
	E/WP-10854-FP WS-1	3	108	54	6250
	E/WP-11454-FP WS-1	3	114	54	6575
E/WP-12054-FP WS-1	3	120	54	6925	

1-WOOD SHELF

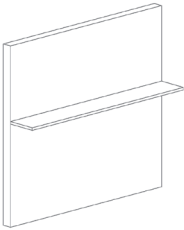
	E/WP-2454 WS-1	3	24	54	1175
	E/WP-3054 WS-1	3	30	54	1575
	E/WP-3654 WS-1	3	36	54	1850
	E/WP-4254 WS-1	3	42	54	2150
	E/WP-4854 WS-1	3	48	54	2425
	E/WP-5454 WS-1	3	54	54	2725
	E/WP-6054 WS-1	3	60	54	3000
	E/WP-6654 WS-1	3	66	54	3275
	E/WP-7254 WS-1	3	72	54	3575
	E/WP-7854 WS-1	3	78	54	3850
	E/WP-8454 WS-1	3	84	54	4125
	E/WP-9054 WS-1	3	90	54	4425
	E/WP-9654 WS-1	3	96	54	4700
	E/WP-10254 WS-1	3	102	54	5000
	E/WP-10854 WS-1	3	108	54	5275
	E/WP-11454 WS-1	3	114	54	5550
E/WP-12054 WS-1	3	120	54	5850	

*Painted finish only available in ARK standard white.

WALL PANEL WOOD SHELVES

54" HEIGHT

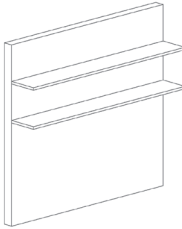
2-WOOD SHELF	MODEL NUMBER	DIMENSIONS			PRICE VENEER/PAINT*
		D	W	H	
	E/WP-2454 WS-2	3	24	54	1275
	E/WP-3054 WS-2	3	30	54	1700
	E/WP-3654 WS-2	3	36	54	2000
	E/WP-4254 WS-2	3	42	54	2325
	E/WP-4854 WS-2	3	48	54	2625
	E/WP-5454 WS-2	3	54	54	2950
	E/WP-6054 WS-2	3	60	54	3250
	E/WP-6654 WS-2	3	66	54	3550
	E/WP-7254 WS-2	3	72	54	3875
	E/WP-7854 WS-2	3	78	54	4175
	E/WP-8454 WS-2	3	84	54	4475
	E/WP-9054 WS-2	3	90	54	4800
	E/WP-9654 WS-2	3	96	54	5100
	E/WP-10254 WS-2	3	102	54	5425
	E/WP-10854 WS-2	3	108	54	5725
	E/WP-11454 WS-2	3	114	54	6025
E/WP-12054 WS-2	3	120	54	6350	

3-WOOD SHELF

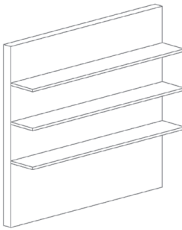
	E/WP-2454 WS-3	3	24	54	1375
	E/WP-3054 WS-3	3	30	54	1825
	E/WP-3654 WS-3	3	36	54	2150
	E/WP-4254 WS-3	3	42	54	2500
	E/WP-4854 WS-3	3	48	54	2825
	E/WP-5454 WS-3	3	54	54	3175
	E/WP-6054 WS-3	3	60	54	3500
	E/WP-6654 WS-3	3	66	54	3825
	E/WP-7254 WS-3	3	72	54	4175
	E/WP-7854 WS-3	3	78	54	4500
	E/WP-8454 WS-3	3	84	54	4825
	E/WP-9054 WS-3	3	90	54	5175
	E/WP-9654 WS-3	3	96	54	5500
	E/WP-10254 WS-3	3	102	54	5850
	E/WP-10854 WS-3	3	108	54	6175
	E/WP-11454 WS-3	3	114	54	6500
E/WP-12054 WS-3	3	120	54	6850	

*Painted finish only available in ARK standard white.

WALL PANEL METAL SHELVES

42" HEIGHT

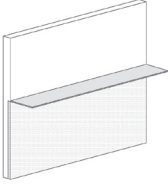
FABRIC PANEL & METAL SHELF	MODEL NUMBER	DIMENSIONS			PRICE VENEER/PAINT*
		D	W	H	
	E/WP-2442-FP MS-1	3	24	42	1175
	E/WP-3042-FP MS-1	3	30	42	1450
	E/WP-3642-FP MS-1	3	36	42	1725
	E/WP-4242-FP MS-1	3	42	42	1975
	E/WP-4842-FP MS-1	3	48	42	2225
	E/WP-5442-FP MS-1	3	54	42	2475
	E/WP-6042-FP MS-1	3	60	42	2875
	E/WP-6642-FP MS-1	3	66	42	3025
	E/WP-7242-FP MS-1	3	72	42	3275
	E/WP-7842-FP MS-1	3	78	42	3525
	E/WP-8442-FP MS-1	3	84	42	3800
	E/WP-9042-FP MS-1	3	90	42	4050
	E/WP-9642-FP MS-1	3	96	42	4325
	E/WP-10242-FP MS-1	3	102	42	4550
	E/WP-10842-FP MS-1	3	108	42	4825
	E/WP-11442-FP MS-1	3	114	42	5100
E/WP-12042-FP MS-1	3	120	42	5350	

1-METAL SHELF

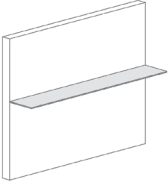
	E/WP-2442 MS-1	3	24	42	875
	E/WP-3042 MS-1	3	30	42	1100
	E/WP-3642 MS-1	3	36	42	1325
	E/WP-4242 MS-1	3	42	42	1525
	E/WP-4842 MS-1	3	48	42	1750
	E/WP-5442 MS-1	3	54	42	1950
	E/WP-6042 MS-1	3	60	42	2300
	E/WP-6642 MS-1	3	66	42	2400
	E/WP-7242 MS-1	3	72	42	2600
	E/WP-7842 MS-1	3	78	42	2825
	E/WP-8442 MS-1	3	84	42	3050
	E/WP-9042 MS-1	3	90	42	3250
	E/WP-9642 MS-1	3	96	42	3475
	E/WP-10242 MS-1	3	102	42	3675
	E/WP-10842 MS-1	3	108	42	3900
	E/WP-11442 MS-1	3	114	42	4125
E/WP-12042 MS-1	3	120	42	4325	

*Painted finish only available in ARK standard white.

WALL PANEL METAL SHELVES

42" HEIGHT

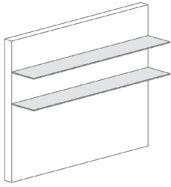
2-METAL SHELF	MODEL NUMBER	DIMENSIONS			PRICE VENEER/PAINT*
		D	W	H	
	E/WP-2442 MS-2	3	24	42	975
	E/WP-3042 MS-2	3	30	42	1250
	E/WP-3642 MS-2	3	36	42	1525
	E/WP-4242 MS-2	3	42	42	1775
	E/WP-4842 MS-2	3	48	42	2050
	E/WP-5442 MS-2	3	54	42	2300
	E/WP-6042 MS-2	3	60	42	2700
	E/WP-6642 MS-2	3	66	42	2850
	E/WP-7242 MS-2	3	72	42	3100
	E/WP-7842 MS-2	3	78	42	3375
	E/WP-8442 MS-2	3	84	42	3650
	E/WP-9042 MS-2	3	90	42	3900
	E/WP-9642 MS-2	3	96	42	4175
	E/WP-10242 MS-2	3	102	42	4425
	E/WP-10842 MS-2	3	108	42	4700
	E/WP-11442 MS-2	3	114	42	4975
E/WP-12042 MS-2	3	120	42	5225	

3-METAL SHELF

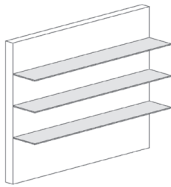
	E/WP-2442 MS-3	3	24	42	1075
	E/WP-3042 MS-3	3	30	42	1400
	E/WP-3642 MS-3	3	36	42	1725
	E/WP-4242 MS-3	3	42	42	2025
	E/WP-4842 MS-3	3	48	42	2350
	E/WP-5442 MS-3	3	54	42	2650
	E/WP-6042 MS-3	3	60	42	3100
	E/WP-6642 MS-3	3	66	42	3300
	E/WP-7242 MS-3	3	72	42	3600
	E/WP-7842 MS-3	3	78	42	3925
	E/WP-8442 MS-3	3	84	42	4250
	E/WP-9042 MS-3	3	90	42	4550
	E/WP-9642 MS-3	3	96	42	4875
	E/WP-10242 MS-3	3	102	42	5175
	E/WP-10842 MS-3	3	108	42	5500
	E/WP-11442 MS-3	3	114	42	5825
E/WP-12042 MS-3	3	120	42	6125	

*Painted finish only available in ARK standard white.

WALL PANEL METAL SHELVES

54" HEIGHT

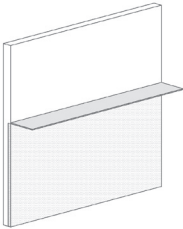
FABRIC PANEL & METAL SHELF	MODEL NUMBER	DIMENSIONS			PRICE VENEER/PAINT*
		D	W	H	
	E/WP-2454-FP MS-1	3	24	54	1150
	E/WP-3054-FP MS-1	3	30	54	1975
	E/WP-3654-FP MS-1	3	36	54	2325
	E/WP-4254-FP MS-1	3	42	54	2675
	E/WP-4854-FP MS-1	3	48	54	3025
	E/WP-5454-FP MS-1	3	54	54	3400
	E/WP-6054-FP MS-1	3	60	54	3750
	E/WP-6654-FP MS-1	3	66	54	4100
	E/WP-7254-FP MS-1	3	72	54	4475
	E/WP-7854-FP MS-1	3	78	54	4825
	E/WP-8454-FP MS-1	3	84	54	5175
	E/WP-9054-FP MS-1	3	90	54	5550
	E/WP-9654-FP MS-1	3	96	54	5875
	E/WP-10254-FP MS-1	3	102	54	6250
	E/WP-10854-FP MS-1	3	108	54	6600
	E/WP-11454-FP MS-1	3	114	54	6950
E/WP-12054-FP MS-1	3	120	54	7325	

1-METAL SHELF

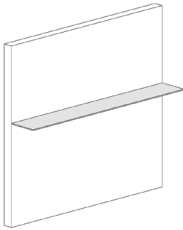
	E/WP-2454 MS-1	3	24	54	1175
	E/WP-3054 MS-1	3	30	54	1600
	E/WP-3654 MS-1	3	36	54	1900
	E/WP-4254 MS-1	3	42	54	2225
	E/WP-4854 MS-1	3	48	54	2525
	E/WP-5454 MS-1	3	54	54	2850
	E/WP-6054 MS-1	3	60	54	3150
	E/WP-6654 MS-1	3	66	54	3450
	E/WP-7254 MS-1	3	72	54	3775
	E/WP-7854 MS-1	3	78	54	4075
	E/WP-8454 MS-1	3	84	54	4375
	E/WP-9054 MS-1	3	90	54	4700
	E/WP-9654 MS-1	3	96	54	5000
	E/WP-10254 MS-1	3	102	54	5325
	E/WP-10854 MS-1	3	108	54	5625
	E/WP-11454 MS-1	3	114	54	5925
E/WP-12054 MS-1	3	120	54	6250	

*Painted finish only available in ARK standard white.

WALL PANEL METAL SHELVES

54" HEIGHT

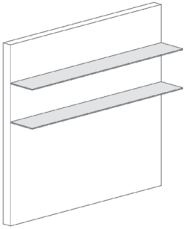
2-METAL SHELF	MODEL NUMBER	DIMENSIONS			PRICE VENEER/PAINT*
		D	W	H	
	E/WP-2454 MS-2	3	24	54	1275
	E/WP-3054 MS-2	3	30	54	1750
	E/WP-3654 MS-2	3	36	54	2100
	E/WP-4254 MS-2	3	42	54	2475
	E/WP-4854 MS-2	3	48	54	2825
	E/WP-5454 MS-2	3	54	54	3200
	E/WP-6054 MS-2	3	60	54	3550
	E/WP-6654 MS-2	3	66	54	3900
	E/WP-7254 MS-2	3	72	54	4275
	E/WP-7854 MS-2	3	78	54	4625
	E/WP-8454 MS-2	3	84	54	4975
	E/WP-9054 MS-2	3	90	54	5350
	E/WP-9654 MS-2	3	96	54	5700
	E/WP-10254 MS-2	3	102	54	6075
	E/WP-10854 MS-2	3	108	54	6425
	E/WP-11454 MS-2	3	114	54	6775
E/WP-12054 MS-2	3	120	54	7150	

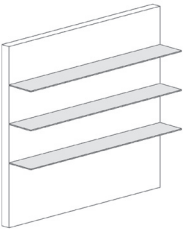
3-METAL SHELF	MODEL NUMBER	DIMENSIONS			PRICE VENEER/PAINT*
		D	W	H	
	E/WP-2454 MS-3	3	24	54	1375
	E/WP-3054 MS-3	3	30	54	1900
	E/WP-3654 MS-3	3	36	54	2300
	E/WP-4254 MS-3	3	42	54	2725
	E/WP-4854 MS-3	3	48	54	3125
	E/WP-5454 MS-3	3	54	54	3550
	E/WP-6054 MS-3	3	60	54	3950
	E/WP-6654 MS-3	3	66	54	4350
	E/WP-7254 MS-3	3	72	54	4775
	E/WP-7854 MS-3	3	78	54	5175
	E/WP-8454 MS-3	3	84	54	5575
	E/WP-9054 MS-3	3	90	54	6000
	E/WP-9654 MS-3	3	96	54	6400
	E/WP-10254 MS-3	3	102	54	6825
	E/WP-10854 MS-3	3	108	54	7225
	E/WP-11454 MS-3	3	114	54	7625
E/WP-12054 MS-3	3	120	54	8050	

*Painted finish only available in ARK standard white.

WALL PANEL GLASS SHELVES

42" HEIGHT

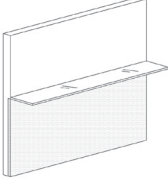
FABRIC PANEL & GLASS SHELF	MODEL NUMBER	DIMENSIONS			PRICE VENEER/PAINT*
		D	W	H	
	E/WP-2442-FP GS-1	3	24	42	1400
	E/WP-3042-FP GS-1	3	30	42	1700
	E/WP-3642-FP GS-1	3	36	42	2025
	E/WP-4242-FP GS-1	3	42	42	2300
	E/WP-4842-FP GS-1	3	48	42	2575
	E/WP-5442-FP GS-1	3	54	42	2850
	E/WP-6042-FP GS-1	3	60	42	3275
	E/WP-6642-FP GS-1	3	66	42	3475
	E/WP-7242-FP GS-1	3	72	42	3750
	E/WP-7842-FP GS-1	3	78	42	4015
	E/WP-8442-FP GS-1	3	84	42	4325
	E/WP-9042-FP GS-1	3	90	42	4600
	E/WP-9642-FP GS-1	3	96	42	4925
	E/WP-10242-FP GS-1	3	102	42	5120
	E/WP-10842-FP GS-1	3	108	42	5475
	E/WP-11442-FP GS-1	3	114	42	5775
E/WP-12042-FP GS-1	3	120	42	6050	

1-GLASS SHELF

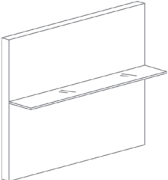
	E/WP-2442 GS-1	3	24	42	1100
	E/WP-3042 GS-1	3	30	42	1350
	E/WP-3642 GS-1	3	36	42	1625
	E/WP-4242 GS-1	3	42	42	1850
	E/WP-4842 GS-1	3	48	42	2100
	E/WP-5442 GS-1	3	54	42	2325
	E/WP-6042 GS-1	3	60	42	2700
	E/WP-6642 GS-1	3	66	42	2850
	E/WP-7242 GS-1	3	72	42	3075
	E/WP-7842 GS-1	3	78	42	3315
	E/WP-8442 GS-1	3	84	42	3575
	E/WP-9042 GS-1	3	90	42	3800
	E/WP-9642 GS-1	3	96	42	4075
	E/WP-10242 GS-1	3	102	42	4245
	E/WP-10842 GS-1	3	108	42	4550
	E/WP-11442 GS-1	3	114	42	4800
E/WP-12042 GS-1	3	120	42	5025	

*Painted finish only available in ARK standard white.

WALL PANEL GLASS SHELVES

42" HEIGHT

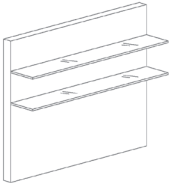
2-GLASS SHELF	MODEL NUMBER	DIMENSIONS			PRICE VENEER/PAINT*
		D	W	H	
	E/WP-2442 GS-2	3	24	42	1425
	E/WP-3042 GS-2	3	30	42	1750
	E/WP-3642 GS-2	3	36	42	2125
	E/WP-4242 GS-2	3	42	42	2425
	E/WP-4842 GS-2	3	48	42	2750
	E/WP-5442 GS-2	3	54	42	3050
	E/WP-6042 GS-2	3	60	42	3500
	E/WP-6642 GS-2	3	66	42	3750
	E/WP-7242 GS-2	3	72	42	4050
	E/WP-7842 GS-2	3	78	42	4355
	E/WP-8442 GS-2	3	84	42	4700
	E/WP-9042 GS-2	3	90	42	5000
	E/WP-9642 GS-2	3	96	42	5375
	E/WP-10242 GS-2	3	102	42	5565
	E/WP-10842 GS-2	3	108	42	6000
	E/WP-11442 GS-2	3	114	42	6325
E/WP-12042 GS-2	3	120	42	6625	

3-GLASS SHELF

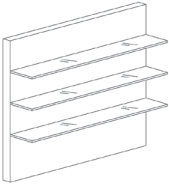
	E/WP-2442 GS-3	3	24	42	1750
	E/WP-3042 GS-3	3	30	42	2150
	E/WP-3642 GS-3	3	36	42	2625
	E/WP-4242 GS-3	3	42	42	3000
	E/WP-4842 GS-3	3	48	42	3400
	E/WP-5442 GS-3	3	54	42	3775
	E/WP-6042 GS-3	3	60	42	4300
	E/WP-6642 GS-3	3	66	42	4650
	E/WP-7242 GS-3	3	72	42	5025
	E/WP-7842 GS-3	3	78	42	5395
	E/WP-8442 GS-3	3	84	42	5825
	E/WP-9042 GS-3	3	90	42	6200
	E/WP-9642 GS-3	3	96	42	6675
	E/WP-10242 GS-3	3	102	42	6885
	E/WP-10842 GS-3	3	108	42	7450
	E/WP-11442 GS-3	3	114	42	7850
E/WP-12042 GS-3	3	120	42	8225	

*Painted finish only available in ARK standard white.

WALL PANEL GLASS SHELVES

54" HEIGHT

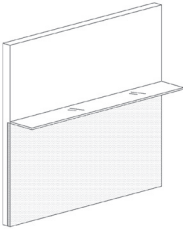
FABRIC PANEL & GLASS SHELF	MODEL NUMBER	DIMENSIONS			PRICE VENEER/PAINT*
		D	W	H	
	E/WP-2454-FP GS-1	3	24	54	1725
	E/WP-3054-FP GS-1	3	30	54	2225
	E/WP-3654-FP GS-1	3	36	54	2625
	E/WP-4254-FP GS-1	3	42	54	3000
	E/WP-4854-FP GS-1	3	48	54	3375
	E/WP-5454-FP GS-1	3	54	54	3775
	E/WP-6054-FP GS-1	3	60	54	4150
	E/WP-6654-FP GS-1	3	66	54	4550
	E/WP-7254-FP GS-1	3	72	54	4950
	E/WP-7854-FP GS-1	3	78	54	5315
	E/WP-8454-FP GS-1	3	84	54	5700
	E/WP-9054-FP GS-1	3	90	54	6100
	E/WP-9654-FP GS-1	3	96	54	6475
	E/WP-10254-FP GS-1	3	102	54	6820
	E/WP-10854-FP GS-1	3	108	54	7250
	E/WP-11454-FP GS-1	3	114	54	7625
E/WP-12054-FP GS-1	3	120	54	8025	

1-GLASS SHELF

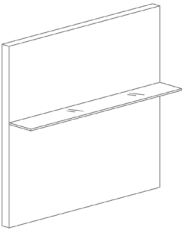
	E/WP-2454 GS-1	3	24	54	1400
	E/WP-3054 GS-1	3	30	54	1850
	E/WP-3654 GS-1	3	36	54	2200
	E/WP-4254 GS-1	3	42	54	2550
	E/WP-4854 GS-1	3	48	54	2875
	E/WP-5454 GS-1	3	54	54	3225
	E/WP-6054 GS-1	3	60	54	3550
	E/WP-6654 GS-1	3	66	54	3900
	E/WP-7254 GS-1	3	72	54	4250
	E/WP-7854 GS-1	3	78	54	4565
	E/WP-8454 GS-1	3	84	54	4900
	E/WP-9054 GS-1	3	90	54	5250
	E/WP-9654 GS-1	3	96	54	5600
	E/WP-10254 GS-1	3	102	54	5895
	E/WP-10854 GS-1	3	108	54	6275
	E/WP-11454 GS-1	3	114	54	6600
E/WP-12054 GS-1	3	120	54	6950	

*Painted finish only available in ARK standard white.

WALL PANEL GLASS SHELVES

54" HEIGHT

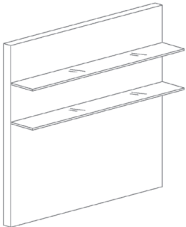
2-GLASS SHELF	MODEL NUMBER	DIMENSIONS			PRICE VENEER/PAINT*
		D	W	H	
	E/WP-2454 GS-2	3	24	54	1725
	E/WP-3054 GS-2	3	30	54	2250
	E/WP-3654 GS-2	3	36	54	2700
	E/WP-4254 GS-2	3	42	54	3125
	E/WP-4854 GS-2	3	48	54	3525
	E/WP-5454 GS-2	3	54	54	3950
	E/WP-6054 GS-2	3	60	54	4350
	E/WP-6654 GS-2	3	66	54	4800
	E/WP-7254 GS-2	3	72	54	5225
	E/WP-7854 GS-2	3	78	54	5605
	E/WP-8454 GS-2	3	84	54	6025
	E/WP-9054 GS-2	3	90	54	6450
	E/WP-9654 GS-2	3	96	54	6900
	E/WP-10254 GS-2	3	102	54	7215
	E/WP-10854 GS-2	3	108	54	7725
	E/WP-11454 GS-2	3	114	54	8125
E/WP-12054 GS-2	3	120	54	8550	

3-GLASS SHELF

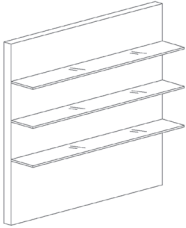
	E/WP-2454 GS-3	3	24	54	2050
	E/WP-3054 GS-3	3	30	54	2650
	E/WP-3654 GS-3	3	36	54	3200
	E/WP-4254 GS-3	3	42	54	3700
	E/WP-4854 GS-3	3	48	54	4175
	E/WP-5454 GS-3	3	54	54	4675
	E/WP-6054 GS-3	3	60	54	5150
	E/WP-6654 GS-3	3	66	54	5700
	E/WP-7254 GS-3	3	72	54	6200
	E/WP-7854 GS-3	3	78	54	6645
	E/WP-8454 GS-3	3	84	54	7150
	E/WP-9054 GS-3	3	90	54	7650
	E/WP-9654 GS-3	3	96	54	8200
	E/WP-10254 GS-3	3	102	54	8535
	E/WP-10854 GS-3	3	108	54	9175
	E/WP-11454 GS-3	3	114	54	9650
E/WP-12054 GS-3	3	120	54	10150	

*Painted finish only available in ARK standard white.

BOOKCASES

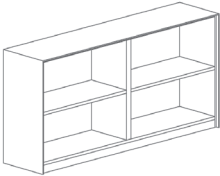
BOOKCASES	MODEL NUMBER	DIMENSIONS			PRICE VENEER
		D	W	H	
	30" WIDTH				
	E/B-30-2H	14	30	29	1925
	E/B-30-3H	14	30	42	2500
	E/B-30-4H	14	30	54	3025
	E/B-30-5H	14	30	68	3550
	E/B-30-6H	14	30	84	4375
	36" WIDTH				
	E/B-36-2H	14	36	29	2200
	E/B-36-3H	14	36	42	2850
	E/B-36-4H	14	36	54	3450
	E/B-36-5H	14	36	68	3875
	E/B-36-6H	14	36	84	4800
	E/B-60-2H	14	60	29	2850
	E/B-72-2H	14	72	29	3325



Architectural Response Kollection
2918 Halladay Street
Santa Ana, CA 92705
714.241.7100
info@ark-inc.com
ark-inc.com