

ARIK

CROSSROADS COLLECTION
2021 PRICE LIST

General & Finish Information	2
Typical Configurations	4
Platforms & Pedestals	6
Worksurfaces & Supports	12
Storage Towers	16
Overhead Storage	20
Fabric Tack Panels & Wall Shelf	24
Bookcases	26
Lighting, Power & Data	27

GENERAL & FINISH INFORMATION

PRICES

All prices are list prices and are effective the date printed on cover and supersedes previous price lists.

Prices shown are for standard product only. Standard product will have additional charges applied to it for any changes made. Architectural Response Kollektion, Inc. reserves the right to change prices and specifications without prior notice. Pricing shown does not include installation, taxes, packaging, crating or storage. Orders are acknowledged with net prices. Minimum order charge is \$50.00 net.

ACKNOWLEDGMENT

Each order will be acknowledged. This acknowledgment is the final agreement between Architectural Response Kollektion, Inc. and the customer, superseding all previous communications regarding the order.

Orders are subject to acquiring the materials required for manufacturing. Fulfillment can be affected by strikes, fires, embargoes and acts of government. These elements are beyond our control.

PAYMENT TERMS

Terms are Net 30 days. Credit references and resale certificate must be submitted prior to receipt of your initial order. Open account status or terms of sale may be established at the discretion of Architectural Response Kollektion, Inc. After 30 days from date of invoice a 1 ½% interest charge will be added on any unpaid balance. Architectural Response Kollektion, Inc. may retain a security interest in the furniture until full payment of the invoice.

ORDERING PROCEDURES

Before placing your order, confirm you have all required information necessary. Lead times for orders begin after all required information is included and signed drawings are received. Orders should be submitted through our authorized Factory Representative or may be sent via email to info@ark-inc.com. Contact information Tel. 714.241.7100 Toll-free 888.241.7100.

PRODUCT DESIGN

Architectural Response Kollektion, Inc. reserves the right to make changes in design and construction or discontinue without prior notice.

CANCELLATIONS AND CHANGES

Request for cancellation must be in written form and reviewed by Architectural Response Kollektion, Inc. if they are of a reasonable nature prior to the start of processing. Processing includes but is not limited to development of shop drawings and other engineering drawings. If cancellation is approved, a processing fee of 25% or more may be imposed based on the status of the order.

Special Product orders may NOT be canceled once entered into production.

Architectural Response Kollektion, Inc. will make every attempt to honor any reasonable change request to product provided once the request is received prior to start of production. Request must be made in writing and received in time to make the change. Architectural Response Kollektion, Inc. reserves the right to increase our acknowledged price and ship date if necessary to make the requested changes.

PACKING

All prices are for blanket wrap. For special packing requirements, contact customer service. All weights stated herein are approximate. All products are shipped according to freight regulations. The ordering party bears the risk of loss or damage during shipment.

DELIVERY & FREIGHT CHARGES

All shipments are FAS point of shipment, freight prepaid and allowed to one continental U.S. destination. All shipments outside the continental U.S. will be shipped FAS origin, freight prepaid to point of embarkation. All charges beyond point of embarkation are collect. Orders in production will be shipped as scheduled and cannot be delayed. The customer obtains title to their product and materials, and assumes the risk of loss for them, upon shipment from Architectural Response Kollektion, Inc. facilities.

Architectural Response Kollektion, Inc. reserves the right to select the most appropriate carrier and routing for all shipments.

STORAGE

Architectural Response Kollektion, Inc. has no storage facilities for finished product. If a customer cannot accept an order when it is ready for shipment, the customer will be charged 1 ½% of invoice for every 30 days or any part thereof, that merchandise remains in facility.

Architectural Response Kollektion, Inc. is not liable for any delay for failure to deliver products due to fires, floods, accidents, labor strikes, lock outs, earthquakes, delay of or failure of material supply sources, acts of God, or any other causes beyond Architectural Response Kollektion, Inc.'s control.

CLAIMS

Architectural Response Kollektion, Inc. takes every precaution to assure proper inspection of the loading and packaging of all merchandise. Our liability ceases when we receive a clear bill of lading at our shipping dock. This is an acknowledgment by the transportation company that the merchandise was received in good condition.

DAMAGED MERCHANDISE

Do not refuse merchandise damaged in transit. All shipments are delivered to the transportation company in good condition. Architectural Response Kollektion, Inc.'s liability ceases at that time. If a shipment is received damaged, you should immediately file a claim with the transportation company. Inspect all cartons upon delivery. Do not destroy packing material until shipment has been inspected. Then proceed to file a claim with the carrier.

CONCEALED DAMAGE & SHORTAGES

Customers are protected from concealed damage and shortages if they file claims with the carrier within five days of delivery. Architectural Response Kollektion, Inc. suggests the words "subject to inspection" accompany signature if goods are crated or cartoned and thus cannot be examined at time of receipt. Any claims for shipping damage must be filed by the customer with the carrier within five days of receipt.

REPAIR CHARGES

Prior written approval is required for repairs of merchandise charged to Architectural Response Kollection, Inc. Failure to do so will result in customer funded repairs. Merchandise may not be returned without our prior written authorization along with shipping instructions. Unauthorized returns will not be accepted and will be returned freight collect.

All merchandise being returned must be properly packed and protected to ensure no further damage is incurred during transportation back to Architectural Response Kollection, Inc.'s facility. Upon receipt all returned merchandise will be thoroughly inspected and the results compared to the reason for return stated on RGA. Any discrepancies, such as additional damage, signs of usage, missing parts etc., will result in an adjustment to the amount of credit issued.

WARRANTY

Architectural Response Kollection, Inc. products are manufactured according to our high standards for fine quality materials and workmanship. We warrant all standard catalog items against failure due to defective materials or workmanship for a period of ten years of single shift service from the date of shipment.

This warranty is applicable only if furniture is properly installed and maintained in an office environment. This warranty does not apply to damages, neglect, misused or altered products, nor defects in materials not manufactured by Architectural Response Kollection, Inc. Excluded from this warranty are leathers, marble, Corian and hard surfaces.

During this warranty period, Architectural Response Kollection Inc.'s sole obligation is to repair or replace at Architectural Response Kollection, Inc.'s discretion, products which prove to be defective during the warranty period.

Architectural Response Kollection, Inc. extends no other warranties, expressed or implied including warranty of merchantability or fitness for a particular purpose. Architectural Response Kollection, Inc. shall not be liable for loss of time, inconvenience, commercial loss, incidental or consequential damages.

STANDARD FEATURES

LOCKS
Standard on all drawer pedestals.
Brushed nickel finish.

PULLS
Standard on all drawers and doors except overhead storage doors.
Brushed nickel finish.

BOX DRAWERS
Top box drawer has one pencil tray.
All box drawers have one fully adjustable divider.

TACK PANEL FABRIC SELECTIONS
Due to fabric manufacturers ongoing fabric additions, color and material changes, all of Architectural Response Kollection, Inc. fabrics are COM.
*Please contact fabric manufacturer for sampling support.

MATERIALS

The first step towards building a quality piece of furniture lies in obtaining the finest materials. Architectural Response Kollection, Inc. has one of the most stringent veneer and hardwood grading standards in the industry.

These fine materials are finished with a highly durable conversion varnish system.

STANDARD FINISHES

*Please see Architectural Response Kollection, Inc. website for standard finishes.

Other wood species available.
Call factory for pricing.
Contact information Tel. 714.241.7100
Toll-free 888.241.7100.

COLOR & GRAIN MATCHING

Different wood species offer unique texture and grain. Variations in finish color and value may occur due to the natural characteristics of wood. Architectural Response Kollection, Inc. carefully selects all materials used in every product to minimize the natural variation in materials. Each color match sample submitted and the furniture you receive may not be an exact match.

When re-ordering furniture for an existing project, where color change has occurred as a natural part of the aging process, please provide sample if color matching is critical.

FABRIC COM

COM is Customer's Own Material. Customer must take full responsibility for selecting, purchasing and shipping COM to Architectural Response Kollection, Inc. All shipments must be clearly marked with the customer's name and customer order number.

A sample must first be sent for Architectural Response Kollection, Inc.'s approval as to whether or not it can be applied on our product.

Your order should indicate which side of the material is to be exposed and if special application instructions apply. Specify the supplier's name, material number and description. If the fabric is a stripe or pattern, specify vertical or horizontal application. In the absence of instructions, Architectural Response Kollection, Inc. will determine the appropriate application.

Yardage requirements shown in the price list assume 60" wide plain fabric.

CARE & MAINTENANCE

WOOD FINISHES
When cleaning wood, use a soft cotton cloth moistened with a mild soap and warm water solution and dry immediately. Architectural Response Kollection, Inc. does not recommend the use of waxes or polish.

In some cases, the rubber support feet used on the bottom of common office equipment (teleconferencing phones, laptops, microphones, copiers, etc.) can create unsightly marks on the surface of wood tops, due to oxidation of the lacquer finish. We suggest these machines be placed on a protective type of padding, such as felt.

STONE & SOLID SURFACE MATERIAL
Despite its reputation for durability, natural stone can easily be broken during handling and/or installation if proper techniques are not followed. Architectural Response Kollection, Inc. is not responsible for the installation of natural stone or solid surface materials on its products. Therefore, installers specially trained in the installation of these materials must be utilized to ensure a quality installation.

Architectural Response Kollection, Inc. shall not be liable for any damages incurred during the handling and/or installation of natural stone or solid surface materials on its products.

TYPICAL CONFIGURATIONS

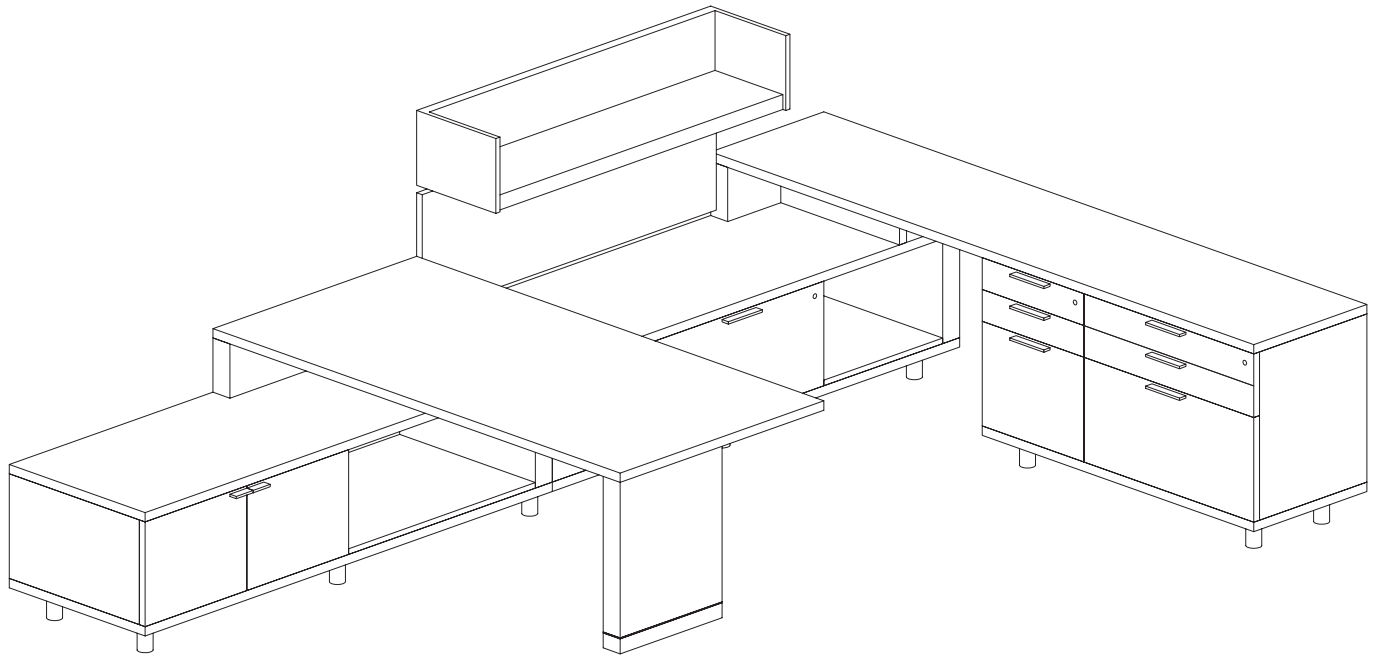

MODEL NUMBER	DESCRIPTION	MATERIAL	PRICE
C/PL-2472-W (2)	Platform	Wood	1525
C/PED-3624-14-S-W	Low Storage Pedestal	Wood	2075
C/PED-1824-14-BBB-W	Low Box/Box/Box Pedestal	Wood	1500
C/PED-3024-14-F-W	Low File Pedestal	Wood	1400
C/SP-324-14-W (2)	End/Mid Support	Wood	800
C/PBS-2433-W	Platform Bottom Shelf	Wood	350
C/PBS-2421-W	Platform Bottom Shelf	Wood	225
C/WS-2472-W (2)	Worksurface	Wood	2150
C/PL-2048-W	Platform	Wood	1200
C/PED-1820-22-BBF-W	Mid Box/Box/File Pedestal	Wood	1250
C/PED-3020-22-BBF-W	Mid Box/Box/File Pedestal	Wood	1650
C/WS-2096-W	Worksurface	Wood	1200
C/WR-20-W	Worksurface Riser	Wood	350
C/CB-21-W	Cross Beam Support	Wood	350
C/DT-3678-R-W	Desk Top	Wood	1700
C/WR-36-W	Worksurface Riser	Wood	425
C/MB-60-W	Desk Modesty Beam Support	Wood	750
C/BP-1828-W	Box Panel Support	Wood	700
C/SH-54-W	Wall Shelf	Wood	1175
C/TP-1654	Fabric Tack Panel	Fabric	450
TOTAL			\$21,225

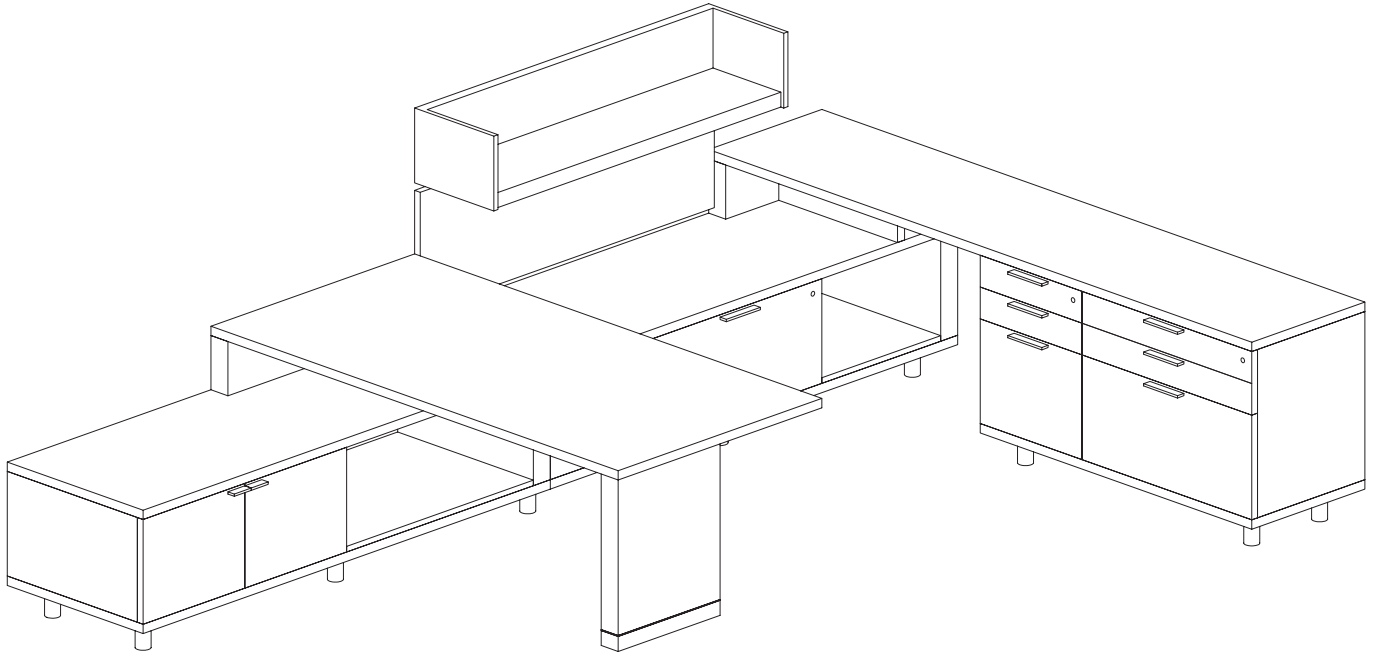

MODEL NUMBER	DESCRIPTION	MATERIAL	PRICE
C/PL-2472-W (2)	Platform	Wood	1375
C/PED-3624-14-S-L	Low Storage Pedestal	Laminate	1875
C/PED-1824-14-BBB-L	Low Box/Box/Box Pedestal	Laminate	1350
C/PED-3024-14-F-L	Low File Pedestal	Laminate	1275
C/SP-324-14-L (2)	End/Mid Support	Laminate	750
C/PBS-2433-L	Platform Bottom Shelf	Laminate	325
C/PBS-2421-L	Platform Bottom Shelf	Laminate	225
C/WS-2472-W (2)	Worksurface	Wood	1950
C/PL-2048-W	Platform	Wood	1100
C/PED-1820-22-BBF-L	Mid Box/Box/File Pedestal	Laminate	1125
C/PED-3020-22-BBF-L	Mid Box/Box/File Pedestal	Laminate	1500
C/WS-2096-W	Worksurface	Wood	1100
C/WR-20-W	Worksurface Riser	Wood	325
C/CB-21-W	Cross Beam Support	Wood	325
C/DT-3678-R-W	Desk Top	Wood	1550
C/WR-36-W	Worksurface Riser	Wood	400
C/MB-60-W	Desk Modesty Beam Support	Wood	675
C/BP-1828-W	Box Panel Support	Wood	650
C/SH-54-W	Wall Shelf	Wood	1175
C/TP-1654	Fabric Tack Panel	Fabric	450
TOTAL			\$19,500

PLATFORMS & PEDESTALS

20" PLATFORMS

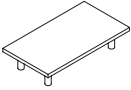
FOUR LEGS	MODEL NUMBER Specify (W)ood or (L)aminate	DIMENSIONS			PRICE	
		D	W	H	(W)OOD	(L)AMINATE
	C/PL-2018-()	20	18	5 1/4	750	675
	C/PL-2024-()	20	24	5 1/4	825	750
	C/PL-2030-()	20	30	5 1/4	900	825
	C/PL-2036-()	20	36	5 1/4	950	875
	C/PL-2042-()	20	42	5 1/4	1025	925
	C/PL-2048-()	20	48	5 1/4	1200	1100

SIX LEGS

	C/PL-2054-()	20	54	5 1/4	1150	1050
	C/PL-2060-()	20	60	5 1/4	1225	1125
	C/PL-2066-()	20	66	5 1/4	1300	1175
	C/PL-2072-()	20	72	5 1/4	1350	1225
	C/PL-2078-()	20	78	5 1/4	1575	1425
	C/PL-2084-()	20	84	5 1/4	1650	1500

EIGHT LEGS

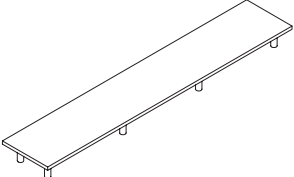
	C/PL-2090-()	20	90	5 1/4	1725	1575
	C/PL-2096-()	20	96	5 1/4	1775	1600
	C/PL-20102-()	20	102	5 1/4	1850	1675
	C/PL-20108-()	20	108	5 1/4	1925	1750
	C/PL-20114-()	20	114	5 1/4	1975	1800
	C/PL-20120-()	20	120	5 1/4	2200	2000

TEN LEGS

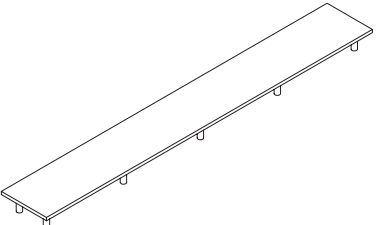
	C/PL-20126-()	20	126	5 1/4	2275	2050
	C/PL-20132-()	20	132	5 1/4	2350	2125
	C/PL-20138-()	20	138	5 1/4	2400	2175
	C/PL-20144-()	20	144	5 1/4	2475	2250

24" PLATFORMS

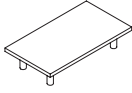
FOUR LEGS	MODEL NUMBER Specify (W)ood or (L)aminate	DIMENSIONS			PRICE	
		D	W	H	(W)OOD	(L)AMINATE
	C/PL-2418-()	24	18	5 1/4	800	725
	C/PL-2424-()	24	24	5 1/4	875	800
	C/PL-2430-()	24	30	5 1/4	950	875
	C/PL-2436-()	24	36	5 1/4	1050	950
	C/PL-2442-()	24	42	5 1/4	1125	1025
	C/PL-2448-()	24	48	5 1/4	1200	1100

SIX LEGS

	C/PL-2454-()	24	54	5 1/4	1275	1150
	C/PL-2460-()	24	60	5 1/4	1350	1225
	C/PL-2466-()	24	66	5 1/4	1450	1325
	C/PL-2472-()	24	72	5 1/4	1525	1375
	C/PL-2478-()	24	78	5 1/4	1750	1575
	C/PL-2484-()	24	84	5 1/4	1825	1650

EIGHT LEGS

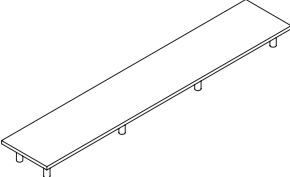
	C/PL-2490-()	24	90	5 1/4	1925	1750
	C/PL-2496-()	24	96	5 1/4	2000	1800
	C/PL-24102-()	24	102	5 1/4	2075	1875
	C/PL-24108-()	24	108	5 1/4	2150	1950
	C/PL-24114-()	24	114	5 1/4	2225	2025
	C/PL-24120-()	24	120	5 1/4	2475	2250

TEN LEGS

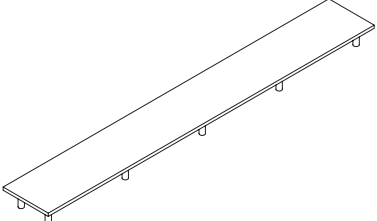
	C/PL-24126-()	24	126	5 1/4	2550	2300
	C/PL-24132-()	24	132	5 1/4	2625	2375
	C/PL-24138-()	24	138	5 1/4	2725	2475
	C/PL-24144-()	24	144	5 1/4	2800	2525

PLATFORMS & PEDESTALS

LOW 20" DEEP PEDESTALS & SUPPORTS

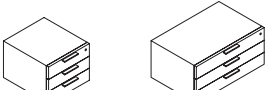
THREE-BOX PEDESTAL	MODEL NUMBER Specify (W)ood or (L)aminate	DIMENSIONS			PRICE	
		D	W	H	(W)OOD	(L)AMINATE
	C/PED-1820-14-BBB-()	20	18	14	1450	1325
	C/PED-2420-14-BBB-()	20	24	14	1600	1450
	C/PED-3020-14-BBB-()	20	30	14	1750	1575
	C/PED-3620-14-BBB-()	20	36	14	1900	1725

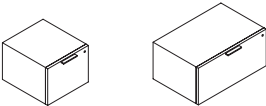
FILE PEDESTAL	MODEL NUMBER Specify (W)ood or (L)aminate	DIMENSIONS			PRICE	
		D	W	H	(W)OOD	(L)AMINATE
	C/PED-1820-14-F-()	20	18	14	1050	950
	C/PED-2420-14-F-()	20	24	14	1200	1100
	C/PED-3020-14-F-()	20	30	14	1350	1225
	C/PED-3620-14-F-()	20	36	14	1500	1350

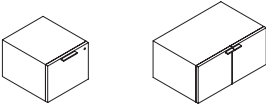
SWING DOOR STORAGE PEDESTAL	MODEL NUMBER Specify (W)ood or (L)aminate	DIMENSIONS			PRICE	
		D	W	H	(W)OOD	(L)AMINATE
	C/PED-1820-14-S-()	20	18	14	1025	925
	C/PED-2420-14-S-()	20	24	14	1425	1300
	C/PED-3020-14-S-()	20	30	14	1625	1475
	C/PED-3620-14-S-()	20	36	14	1850	1675

END/MID SUPPORT	MODEL NUMBER Specify (W)ood or (L)aminate	DIMENSIONS			PRICE	
		D	W	H	(W)OOD	(L)AMINATE
	C/SP-320-14-()	20	3	14	375	350

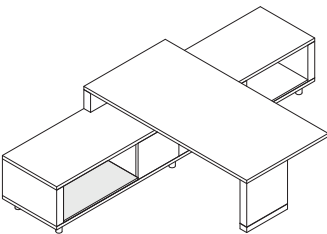
PLATFORM BOTTOM SHELF	MODEL NUMBER Specify (W)ood or (L)aminate	DIMENSIONS			PRICE	
		D	W	H	(W)OOD	(L)AMINATE
	C/PBS-2012-()	20	12	³ / ₄	125	125
	C/PBS-2015-()	20	15	³ / ₄	150	150
	C/PBS-2018-()	20	18	³ / ₄	175	175
	C/PBS-2021-()	20	21	³ / ₄	200	200
	C/PBS-2024-()	20	24	³ / ₄	225	225
	C/PBS-2027-()	20	27	³ / ₄	250	225
	C/PBS-2030-()	20	30	³ / ₄	275	250
	C/PBS-2033-()	20	33	³ / ₄	300	275
	C/PBS-2036-()	20	36	³ / ₄	325	300
	C/PBS-2039-()	20	39	³ / ₄	350	325
	C/PBS-2042-()	20	42	³ / ₄	375	350

MID 20" DEEP PEDESTALS & SUPPORTS

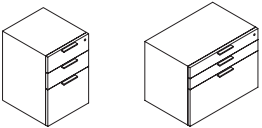
BOX / BOX / FILE PEDESTAL	MODEL NUMBER Specify (W)ood or (L)aminate	DIMENSIONS			PRICE	
		D	W	H	(W)OOD	(L)AMINATE
	C/PED-1820-22-BBF-()	20	18	22 1/2	1250	1125
	C/PED-2420-22-BBF-()	20	24	22 1/2	1550	1400
	C/PED-3020-22-BBF-()	20	30	22 1/2	1650	1500
	C/PED-3620-22-BBF-()	20	36	22 1/2	1800	1625

BOX / FILE PEDESTAL

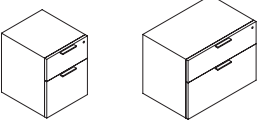
	C/PED-1820-22-BF-()	20	18	22 1/2	1000	900
	C/PED-2420-22-BF-()	20	24	22 1/2	1275	1150
	C/PED-3020-22-BF-()	20	30	22 1/2	1375	1250
	C/PED-3620-22-BF-()	20	36	22 1/2	1500	1350

SWING DOOR STORAGE PEDESTAL

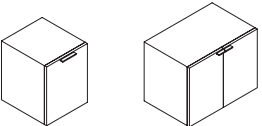
	C/PED-1820-22-S-()	20	18	22 1/2	1300	1175
	C/PED-2420-22-S-()	20	24	22 1/2	1400	1275
	C/PED-3020-22-S-()	20	30	22 1/2	1575	1425
	C/PED-3620-22-S-()	20	36	22 1/2	1775	1600

END/MID SUPPORT

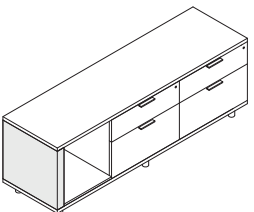
	C/SP-320-22-()	20	3	22 1/2	525	475
------------------------------------------------------------------------------------	-----------------	----	---	--------	-----	-----

PLATFORMS & PEDESTALS

LOW 24" DEEP PEDESTALS & SUPPORTS

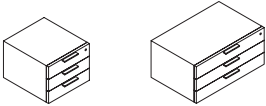
THREE-BOX PEDESTAL	MODEL NUMBER Specify (W)ood or (L)aminate	DIMENSIONS			PRICE	
		D	W	H	(W)OOD	(L)AMINATE
	C/PED-1824-14-BBB-()	24	18	14	1500	1350
	C/PED-2424-14-BBB-()	24	24	14	1675	1525
	C/PED-3024-14-BBB-()	24	30	14	1825	1650
	C/PED-3624-14-BBB-()	24	36	14	1975	1800

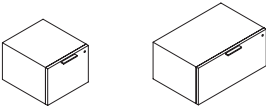
FILE PEDESTAL	MODEL NUMBER Specify (W)ood or (L)aminate	DIMENSIONS			PRICE	
		D	W	H	(W)OOD	(L)AMINATE
	C/PED-1824-14-F-()	24	18	14	1125	1025
	C/PED-2424-14-F-()	24	24	14	1275	1150
	C/PED-3024-14-F-()	24	30	14	1400	1275
	C/PED-3624-14-F-()	24	36	14	1575	1425

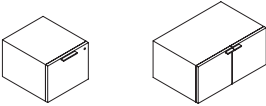
SWING DOOR STORAGE PEDESTAL	MODEL NUMBER Specify (W)ood or (L)aminate	DIMENSIONS			PRICE	
		D	W	H	(W)OOD	(L)AMINATE
	C/PED-1824-14-S-()	24	18	14	1150	1050
	C/PED-2424-14-S-()	24	24	14	1575	1425
	C/PED-3024-14-S-()	24	30	14	1825	1650
	C/PED-3624-14-S-()	24	36	14	2075	1875

END/MID SUPPORT	MODEL NUMBER Specify (W)ood or (L)aminate	DIMENSIONS			PRICE	
		D	W	H	(W)OOD	(L)AMINATE
	C/SP-324-14-()	24	3	14	400	375

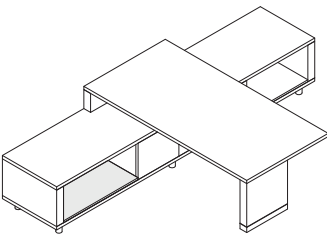
PLATFORM BOTTOM SHELF	MODEL NUMBER Specify (W)ood or (L)aminate	DIMENSIONS			PRICE	
		D	W	H	(W)OOD	(L)AMINATE
	C/PBS-2412-()	24	18	³ / ₄	125	125
	C/PBS-2415-()	24	24	³ / ₄	150	150
	C/PBS-2418-()	24	24	³ / ₄	200	200
	C/PBS-2421-()	24	24	³ / ₄	225	225
	C/PBS-2424-()	24	24	³ / ₄	250	225
	C/PBS-2427-()	24	24	³ / ₄	275	250
	C/PBS-2430-()	24	24	³ / ₄	300	275
	C/PBS-2433-()	24	24	³ / ₄	350	325
	C/PBS-2436-()	24	24	³ / ₄	375	350
	C/PBS-2439-()	24	24	³ / ₄	400	375
	C/PBS-2442-()	24	24	³ / ₄	425	400

MID 24" DEEP PEDESTALS & SUPPORTS

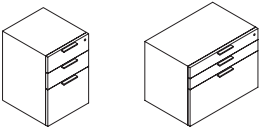
BOX / BOX / FILE PEDESTAL	MODEL NUMBER Specify (W)ood or (L)aminate	DIMENSIONS			PRICE	
		D	W	H	(W)OOD	(L)AMINATE
	C/PED-1824-22-BBF-()	24	18	22 1/2	1275	1150
	C/PED-2424-22-BBF-()	24	24	22 1/2	1600	1450
	C/PED-3024-22-BBF-()	24	30	22 1/2	1700	1550
	C/PED-3624-22-BBF-()	24	36	22 1/2	1825	1650

BOX / FILE PEDESTAL

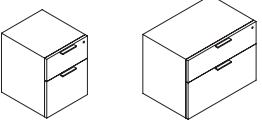
	C/PED-1824-22-BF-()	24	18	22 1/2	1025	925
	C/PED-2424-22-BF-()	24	24	22 1/2	1325	1200
	C/PED-3024-22-BF-()	24	30	22 1/2	1425	1300
	C/PED-3624-22-BF-()	24	36	22 1/2	1550	1400

SWING DOOR STORAGE PEDESTAL

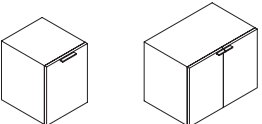
	C/PED-1824-22-S-()	24	18	22 1/2	1325	1200
	C/PED-2424-22-S-()	24	24	22 1/2	1500	1350
	C/PED-3024-22-S-()	24	30	22 1/2	1625	1475
	C/PED-3624-22-S-()	24	36	22 1/2	1800	1625

END/MID SUPPORT

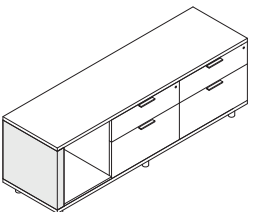
	C/SP-324-22-()	24	3	22 1/2	800	725
------------------------------------------------------------------------------------	-----------------	----	---	--------	-----	-----

WORKSURFACES & SUPPORTS

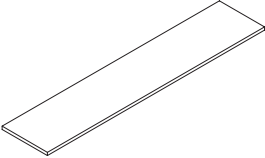

WORKSURFACES

20" DEEP WORKSURFACE	MODEL NUMBER Specify (W)ood or (L)aminate	DIMENSIONS			PRICE	
		D	W	H	(W)OOD	(L)AMINATE
	C/WS-2018-()	20	18	1 1/4	250	225
	C/WS-2024-()	20	24	1 1/4	325	300
	C/WS-2030-()	20	30	1 1/4	400	375
	C/WS-2036-()	20	36	1 1/4	475	450
	C/WS-2042-()	20	42	1 1/4	550	500
	C/WS-2048-()	20	48	1 1/4	625	575
	C/WS-2054-()	20	54	1 1/4	700	650
	C/WS-2060-()	20	60	1 1/4	750	675
	C/WS-2066-()	20	66	1 1/4	825	750
	C/WS-2072-()	20	72	1 1/4	900	825
	C/WS-2078-()	20	78	1 1/4	975	900
	C/WS-2084-()	20	84	1 1/4	1050	950
	C/WS-2090-()	20	90	1 1/4	1125	1025
	C/WS-2096-()	20	96	1 1/4	1200	1100
	C/WS-20102-()	20	102	1 1/4	1275	1150
	C/WS-20108-()	20	108	1 1/4	1350	1225
	C/WS-20114-()	20	114	1 1/4	1425	1300
	C/WS-20120-()	20	120	1 1/4	1500	1350
	C/WS-20126-()	20	126	1 1/4	1550	1400
	C/WS-20132-()	20	132	1 1/4	1625	1475
C/WS-20138-()	20	138	1 1/4	1700	1550	
C/WS-20144-()	20	144	1 1/4	1775	1600	

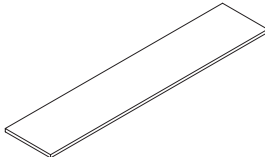
24" DEEP WORKSURFACE

	C/WS-2418-()	24	18	1 1/4	300	275
	C/WS-2424-()	24	24	1 1/4	375	350
	C/WS-2430-()	24	30	1 1/4	475	450
	C/WS-2436-()	24	36	1 1/4	550	500
	C/WS-2442-()	24	42	1 1/4	650	600
	C/WS-2448-()	24	48	1 1/4	725	675
	C/WS-2454-()	24	54	1 1/4	800	725
	C/WS-2460-()	24	60	1 1/4	900	825
	C/WS-2466-()	24	66	1 1/4	975	900
	C/WS-2472-()	24	72	1 1/4	1075	975
	C/WS-2478-()	24	78	1 1/4	1150	1050
	C/WS-2484-()	24	84	1 1/4	1250	1125
	C/WS-2490-()	24	90	1 1/4	1325	1200
	C/WS-2496-()	24	96	1 1/4	1425	1300
	C/WS-24102-()	24	102	1 1/4	1500	1350
	C/WS-24108-()	24	108	1 1/4	1600	1450
	C/WS-24114-()	24	114	1 1/4	1675	1525
	C/WS-24120-()	24	120	1 1/4	1750	1575
	C/WS-24126-()	24	126	1 1/4	1850	1675
	C/WS-24132-()	24	132	1 1/4	1925	1750
C/WS-24138-()	24	138	1 1/4	2025	1825	
C/WS-24144-()	24	144	1 1/4	2100	1900	

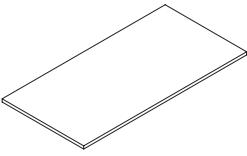
DESK TOPS

DESK WORKSURFACE	MODEL NUMBER Specify (W)ood or (L)aminate	DIMENSIONS			PRICE	
		D	W	H	(W)OOD	(L)AMINATE
	30" DEEP					
	C/DT-3060-R-()	30	60	1 1/4	1100	1000
	C/DT-3066-R-()	30	66	1 1/4	1200	1100
	C/DT-3072-R-()	30	72	1 1/4	1325	1200
	C/DT-3078-R-()	30	78	1 1/4	1425	1300
C/DT-3084-R-()	30	84	1 1/4	1525	1375	
	36" DEEP					
	C/DT-3660-R-()	36	60	1 1/4	1300	1175
	C/DT-3666-R-()	36	66	1 1/4	1450	1325
	C/DT-3672-R-()	36	72	1 1/4	1575	1425
	C/DT-3678-R-()	36	78	1 1/4	1700	1550
C/DT-3684-R-()	36	84	1 1/4	1825	1650	

BRIDGE

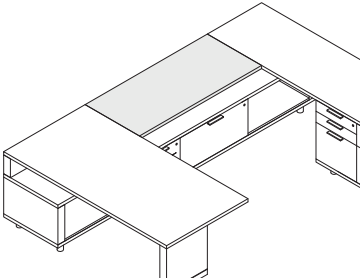
	20" DEEP					
	C/BT-2042-R-()	20	42	1 1/4	975	900
	C/BT-2048-R-()	20	48	1 1/4	1250	1125
	C/BT-2054-R-()	20	54	1 1/4	1350	1225
	C/BT-2060-R-()	20	60	1 1/4	1450	1325
	24" DEEP					
	C/BT-2442-R-()	24	42	1 1/4	1075	975
	C/BT-2448-R-()	24	48	1 1/4	1350	1225
	C/BT-2454-R-()	24	54	1 1/4	1475	1350
C/BT-2460-R-()	24	60	1 1/4	1575	1425	

Bridges longer than 42" require a 12" cross-beam support (see page 18)

WORKSURFACES & SUPPORTS

DESK & CREDENZA SUPPORTS

BOX / BOX / FILE DESK SUPPORT	MODEL NUMBER Specify (W)ood or (L)aminate	DIMENSIONS			PRICE	
		D	W	H	(W)OOD	(L)AMINATE
	PEDESTAL					
	C/SPED-2418-22-BBF-()	24	18	22 1/2	1200	1100
	C/SPED-3018-22-BBF-()	30	18	22 1/2	1425	1300
	C/SPED-3618-22-BBF-()	36	18	22 1/2	1525	1375
	C/SPED-4218-22-BBF-()	42	18	22 1/2	1625	1475
	PLATFORM					
	C/PL-2418-()	24	18	5 1/4	800	725
	C/PL-3018-()	30	18	5 1/4	850	775
	C/PL-3618-()	36	18	5 1/4	925	850
	C/PL-4218-()	42	18	5 1/4	975	900

BOX PANEL SUPPORT

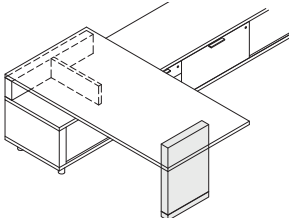
	C/BP-1828-()	3	18	27 3/4	700	650
	C/BP-2428-()	3	24	27 3/4	825	750
	With brushed aluminum reveal.					

END PANEL

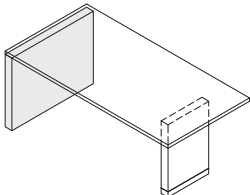
	C/EP-2028-()	3	20	27 3/4	1100	1000
	C/EP-2428-()	3	24	27 3/4	1250	1125
	C/EP-3028-()	3	30	27 3/4	1475	1350
	C/EP-3628-()	3	36	27 3/4	1700	1550
	C/EP-4228-()	3	42	27 3/4	1925	1750

WORKSURFACE RISER

	C/WR-20-()	3	20	7 1/4	350	325
	C/WR-24-()	3	24	7 1/4	350	325
	C/WR-30-()	3	30	7 1/4	400	375
	C/WR-36-()	3	36	7 1/4	425	400
	C/WR-42-()	3	42	7 1/4	450	425

DESK & CREDENZA SUPPORTS

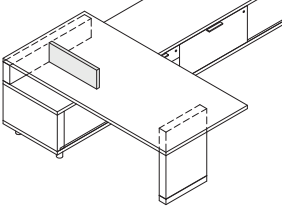
CROSS BEAM SUPPORT	MODEL NUMBER Specify (W)ood or (L)aminate	DIMENSIONS			PRICE	
		D	W	H	(W)OOD	(L)AMINATE
	C/CB-12-()	1 1/4	12	7 1/4	300	275
	C/CB-17-()	1 1/4	17	7 1/4	325	300
	C/CB-21-()	1 1/4	21	7 1/4	350	325

DESK MODESTY BEAM SUPPORT

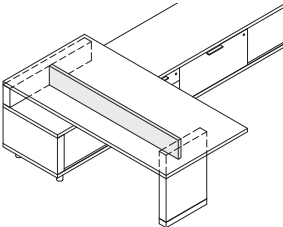
	C/MB-(W)-()	1 1/4	48	7 1/4	600	550
	C/MB-(W)-()	1 1/4	54	7 1/4	675	625
	C/MB-(W)-()	1 1/4	60	7 1/4	750	675
	C/MB-(W)-()	1 1/4	66	7 1/4	825	750
	C/MB-(W)-()	1 1/4	72	7 1/4	900	825
	C/MB-(W)-()	1 1/4	78	7 1/4	975	900

DESK MODESTY PANEL

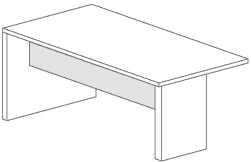
	C/MP-(W)-15-()	3/4	48	15	450	425
	C/MP-(W)-15-()	3/4	54	15	525	475
	C/MP-(W)-15-()	3/4	54	15	600	550
	C/MP-(W)-15-()	3/4	54	15	675	625
	C/MP-(W)-15-()	3/4	60	15	750	675
	C/MP-(W)-15-()	3/4	66	15	825	750
	C/MP-(W)-15-()	3/4	72	15	900	825
	C/MP-(W)-15-()	3/4	78	15	975	900

STORAGE TOWERS

70" STORAGE TOWERS WITH WOOD DOORS

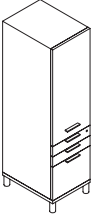
CLOSED STORAGE / BOX / BOX / FILE	MODEL NUMBER Specify (W)ood or (L)aminatE	DIMENSIONS			PRICE	
		D	W	H	(W)OOD	(L)AMINATE
	20" DEEP					
	C/ST-2018-70-SBBF-()	20	18	70	4450	4025
	C/ST-2024-70-SBBF-()	20	24	70	5175	4675
	24" DEEP					
	C/ST-2418-70-SBBF-()	24	18	70	4850	4375
	C/ST-2424-70-SBBF-()	24	24	70	5650	5100

CLOSED STORAGE / BOX / BOX / FILE

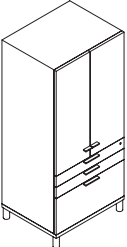
	20" DEEP					
	C/ST-2030-70-SBBF-()	20	30	70	6025	5425
	C/ST-2036-70-SBBF-()	20	36	70	6750	6075
	24" DEEP					
	C/ST-2430-70-SBBF-()	24	30	70	6550	5900
	C/ST-2436-70-SBBF-()	24	36	70	7325	6600

CLOSED STORAGE / BOX / BOX / FILE / WARDROBE

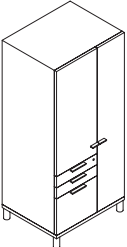
	20" DEEP					
	C/ST-2030-70-SBBFW-()	20	30	70	5525	4975
	C/ST-2036-70-SBBFW-()	20	36	70	6075	5475
	24" DEEP					
	C/ST-2430-70-SBBFW-()	24	30	70	5950	5375
	C/ST-2436-70-SBBFW-()	24	36	70	6500	5850

OPEN DISPLAY / BOX / BOX / FILE / WARDROBE

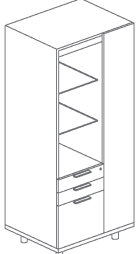
	20" DEEP					
	C/ST-2030-70-DBBFW-()	20	30	70	5000	4500
	C/ST-2036-70-DBBFW-()	20	36	70	6125	5525
	24" DEEP					
	C/ST-2430-70-DBBFW-()	24	30	70	6500	5850
	C/ST-2436-70-DBBFW-()	24	36	70	7175	6475

84" STORAGE TOWERS WITH WOOD DOORS

CLOSED STORAGE / BOX / BOX / FILE	MODEL NUMBER Specify (W)ood or (L)aminate	DIMENSIONS			PRICE	
		D	W	H	(W)OOD	(L)AMINATE
	20" DEEP					
	C/ST-2018-84-SBBF-()	20	18	84	4950	4475
	C/ST-2024-84-SBBF-()	20	24	84	5475	4950
	24" DEEP					
	C/ST-2418-84-SBBF-()	24	18	84	5225	4725
	C/ST-2424-84-SBBF-()	24	24	84	6025	5425

CLOSED STORAGE / BOX / BOX / FILE

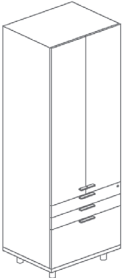
	20" DEEP					
	C/ST-2030-84-SBBF-()	20	30	84	6425	5800
	C/ST-2036-84-SBBF-()	20	36	84	7175	6475
	24" DEEP					
	C/ST-2430-84-SBBF-()	24	30	84	6950	6275
	C/ST-2436-84-SBBF-()	24	36	84	7775	7000

CLOSED STORAGE / BOX / BOX / FILE / WARDROBE

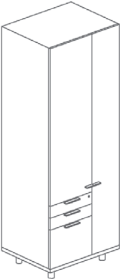
	20" DEEP					
	C/ST-2030-84-SBBFW-()	20	30	84	6225	5625
	C/ST-2036-84-SBBFW-()	20	36	84	7825	7050
	24" DEEP					
	C/ST-2430-84-SBBFW-()	24	30	84	7625	6875
	C/ST-2436-84-SBBFW-()	24	36	84	8375	7550

OPEN DISPLAY / BOX / BOX / FILE / WARDROBE

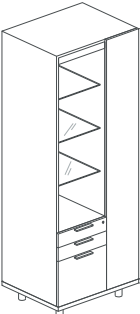
	20" DEEP					
	C/ST-2030-84-DBBFW-()	20	30	84	6600	5950
	C/ST-2036-84-DBBFW-()	20	36	84	7200	6500
	24" DEEP					
	C/ST-2430-84-DBBFW-()	24	30	84	6800	6125
	C/ST-2436-84-DBBFW-()	24	36	84	7425	6700

STORAGE TOWERS

70" STORAGE TOWERS WITH GLASS DOORS

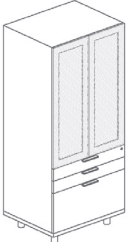
CLOSED STORAGE / BOX / BOX / FILE	MODEL NUMBER Specify (W)ood or (L)aminate	DIMENSIONS			PRICE	
		D	W	H	(W)OOD	(L)AMINATE
	20" DEEP					
	C/ST-2030-70-SBBF-G-()	20	30	70	6425	5800
	C/ST-2036-70-SBBF-G-()	20	36	70	6875	6200
	24" DEEP					
	C/ST-2430-70-SBBF-G-()	24	30	70	6200	5600
	C/ST-2436-70-SBBF-G-()	24	36	70	6650	6000

CLOSED STORAGE / BOX / BOX / FILE / WARDROBE

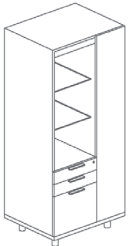
	20" DEEP					
	C/ST-2030-70-SBBFW-G-()	20	30	70	6625	5975
	C/ST-2036-70-SBBFW-G-()	20	36	70	7050	6350
	24" DEEP					
	C/ST-2430-70-SBBFW-G-()	24	30	70	7050	6350
	C/ST-2436-70-SBBFW-G-()	24	36	70	7950	7175

OPEN DISPLAY / BOX / BOX / FILE / WARDROBE

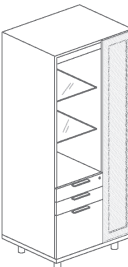
	20" DEEP					
	C/ST-2030-70-DBBFW-G-()	20	30	70	6375	5750
	C/ST-2036-70-DBBFW-G-()	20	36	70	6800	6125
	24" DEEP					
	C/ST-2430-70-DBBFW-G-()	24	30	70	6850	6175
	C/ST-2436-70-DBBFW-G-()	24	36	70	7400	6675

84" STORAGE TOWERS WITH GLASS DOORS

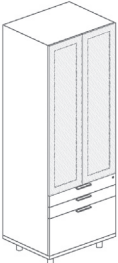
CLOSED STORAGE / BOX / BOX / FILE	MODEL NUMBER Specify (W)ood or (L)aminate	DIMENSIONS			PRICE	
		D	W	H	(W)OOD	(L)AMINATE
	20" DEEP					
	C/ST-2030-84-SBBF-G-()	20	30	84	6775	6100
	C/ST-2036-84-SBBF-G-()	20	36	84	7375	6650
	24" DEEP					
	C/ST-2430-84-SBBF-G-()	24	30	84	7650	6900
	C/ST-2436-84-SBBF-G-()	24	36	84	8075	7275

CLOSED STORAGE / BOX / BOX / FILE / WARDROBE

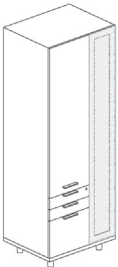
	20" DEEP					
	C/ST-2030-84-SBBFW-G-()	20	30	84	6225	5625
	C/ST-2036-84-SBBFW-G-()	20	36	84	7825	7050
	24" DEEP					
	C/ST-2430-84-SBBFW-G-()	24	30	84	7625	6875
	C/ST-2436-84-SBBFW-G-()	24	36	84	8375	7550

OPEN DISPLAY / BOX / BOX / FILE / WARDROBE

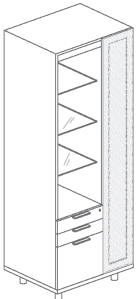
	20" DEEP					
	C/ST-2030-84-DBBFW-G-()	20	30	84	6525	5875
	C/ST-2036-84-DBBFW-G-()	20	36	84	7025	6325
	24" DEEP					
	C/ST-2430-84-DBBFW-G-()	24	30	84	6825	6150
	C/ST-2436-84-DBBFW-G-()	24	36	84	7250	6525

OVERHEAD STORAGE

SINGLE OVERHEAD STORAGE WITH WOOD DOORS

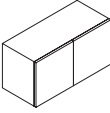
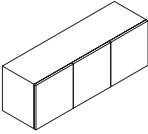
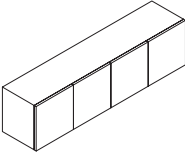
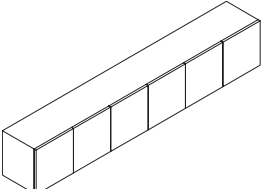
	MODEL NUMBER Specify (W)ood or (L)aminate	DIMENSIONS			PRICE	
		D	W	H	(W)OOD	(L)AMINATE
	C/OH-3016-W-()	15	30	16	1675	1525
	C/OH-3616-W-()	15	36	16	1850	1675
	C/OH-4216-W-()	15	42	16	2225	2025
	C/OH-4816-W-()	15	48	16	2400	2175
	C/OH-5416-W-()	15	54	16	2700	2450
	C/OH-6016-W-()	15	60	16	2975	2700
	C/OH-6616-W-()	15	66	16	3150	2850
	C/OH-7216-W-()	15	72	16	3350	3025
	C/OH-7816-W-()	15	78	16	3800	3425
	C/OH-8416-W-()	15	84	16	4150	3750
	C/OH-9016-W-()	15	90	16	4325	3900
	C/OH-9616-W-()	15	96	16	4525	4075
	C/OH-10216-W-()	15	102	16	4700	4250
	C/OH-10816-W-()	15	108	16	4875	4400

Wall-hung overhead storage cabinets are supplied with a mounting cleat but do not include cleat attachment hardware. It is the responsibility of the purchaser to ensure that the supporting wall structure and cleat attachment method will support the size and weight of the specific cabinet selected. Wall backing is recommended.

DOUBLE OVERHEAD STORAGE WITH WOOD DOORS

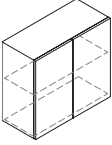
	MODEL NUMBER Specify (W)ood or (L)aminate	DIMENSIONS			PRICE	
		D	W	H	(W)OOD	(L)AMINATE
	C/OH-3030-W-()	15	30	30	2300	2075
	C/OH-3630-W-()	15	36	30	2300	2075

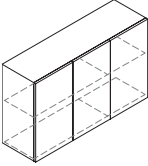
	C/OH-4230-W-()	15	42	30	3125	2825
	C/OH-4830-W-()	15	48	30	3400	3075
	C/OH-5430-W-()	15	54	30	3675	3325

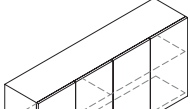
	C/OH-6030-W-()	15	60	30	4225	3825
	C/OH-6630-W-()	15	66	30	4500	4050
	C/OH-7230-W-()	15	72	30	4775	4300
	C/OH-7830-W-()	15	78	30	5325	4800
	C/OH-8430-W-()	15	84	30	6150	5550

	C/OH-9030-W-()	15	90	30	6425	5800
	C/OH-9630-W-()	15	96	30	6700	6050
	C/OH-10230-W-()	15	102	30	6975	6300
	C/OH-10830-W-()	15	108	30	7250	6525

Wall-hung overhead storage cabinets are supplied with a mounting cleat but do not include cleat attachment hardware. It is the responsibility of the purchaser to ensure that the supporting wall structure and cleat attachment method will support the size and weight of the specific cabinet selected. Wall backing is recommended.

OVERHEAD STORAGE

SINGLE OVERHEAD STORAGE WITH GLASS DOORS

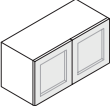
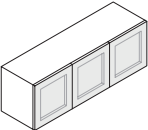
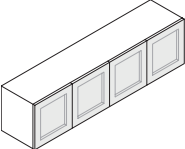
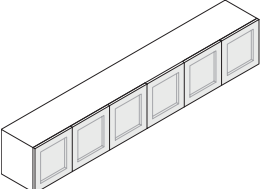
	MODEL NUMBER Specify (W)ood or (L)aminate	DIMENSIONS			PRICE	
		D	W	H	(W)OOD	(L)AMINATE
	C/OH-3016-G-()	15	30	16	2025	1825
	C/OH-3616-G-()	15	36	16	2150	1950
	C/OH-4216-G-()	15	42	16	2800	2525
	C/OH-4816-G-()	15	48	16	2925	2650
	C/OH-5416-G-()	15	54	16	3150	2850
	C/OH-6016-G-()	15	60	16	3700	3350
	C/OH-6616-G-()	15	66	16	3825	3450
	C/OH-7216-G-()	15	72	16	4022	3625
	C/OH-7816-G-()	15	78	16	4375	3950
	C/OH-8416-G-()	15	84	16	4500	4050
	C/OH-9016-G-()	15	90	16	5450	4925
	C/OH-9616-G-()	15	96	16	5575	5025
	C/OH-10216-G-()	15	102	16	5700	5150
	C/OH-10816-G-()	15	108	16	5825	5250

Wall-hung overhead storage cabinets are supplied with a mounting cleat but do not include cleat attachment hardware. It is the responsibility of the purchaser to ensure that the supporting wall structure and cleat attachment method will support the size and weight of the specific cabinet selected. Wall backing is recommended.

DOUBLE OVERHEAD STORAGE WITH GLASS DOORS

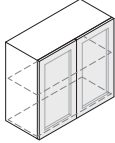
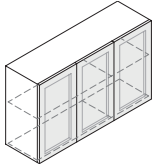
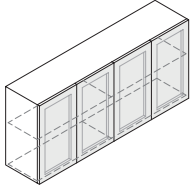
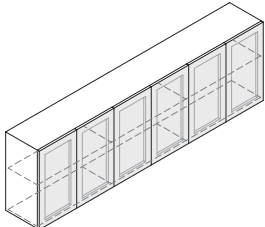
	MODEL NUMBER Specify (W)ood or (L)aminate	DIMENSIONS			PRICE	
		D	W	H	(W)OOD	(L)AMINATE
	C/OH-3030-G-()	15	30	30	2575	2325
	C/OH-3630-G-()	15	36	30	2775	2500
	C/OH-4230-G-()	15	42	30	3575	3225
	C/OH-4830-G-()	15	48	30	3775	3400
	C/OH-5430-G-()	15	54	30	3975	3600
	C/OH-6030-G-()	15	60	30	4775	4300
	C/OH-6630-G-()	15	66	30	4975	4500
	C/OH-7230-G-()	15	72	30	5175	4675
	C/OH-7830-G-()	15	78	30	5650	5100
	C/OH-8430-G-()	15	84	30	6400	5775
	C/OH-9030-G-()	15	90	30	6600	5950
	C/OH-9630-G-()	15	96	30	6800	6125
	C/OH-10230-G-()	15	102	30	7000	6300
	C/OH-10830-G-()	15	108	30	7200	6500

Wall-hung overhead storage cabinets are supplied with a mounting cleat but do not include cleat attachment hardware. It is the responsibility of the purchaser to ensure that the supporting wall structure and cleat attachment method will support the size and weight of the specific cabinet selected. Wall backing is recommended.

FABRIC TACK PANELS & WALL SHELF

OVERHEAD FABRIC TACK PANELS

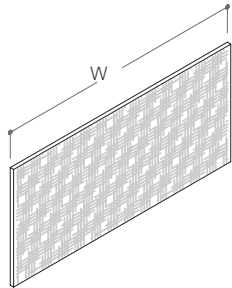

MODEL NUMBER	DIMENSIONS			PRICE
	D	W	H	
C/FP-2424	2	24	24	350
C/FP-3024	2	30	24	400
C/FP-3624	2	36	24	475
C/FP-4224	2	42	24	525
C/FP-4824	2	48	24	575
C/FP-5424	2	54	24	625
C/FP-6024	2	60	24	675
C/FP-6624	2	66	24	750
C/FP-7224	2	72	24	800
C/FP-7824	2	78	24	850
C/FP-8424	2	84	24	900
C/FP-9024	2	90	24	975
C/FP-9624	2	96	24	1025
C/FP-10224	2	102	24	1075
C/FP-10824	2	108	24	1125
C/FP-11424	2	114	24	1175
C/FP-12024	2	120	24	1250

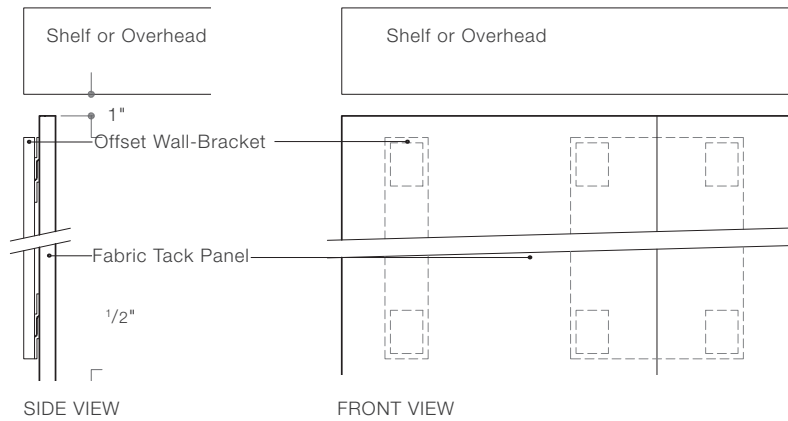

Tackable fabric panels are wall-mounted by means of offset wall-brackets. The appropriate brackets are included with the panel.

FABRIC TACK PANELS & WALL SHELF

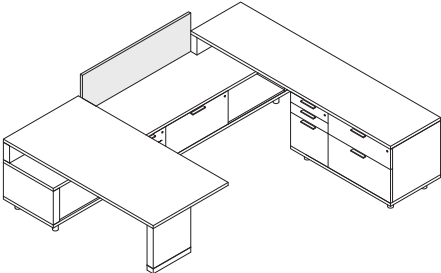
SHELF FABRIC TACK PANELS	MODEL NUMBER	DIMENSIONS			PRICE
		D	W	H	
	C/FP-1630	1	30	16	400
	C/FP-1636	1	36	16	450
	C/FP-1642	1	42	16	500
	C/FP-1648	1	48	16	550
	C/FP-1654	1	54	16	600
	C/FP-1660	1	60	16	650
	C/FP-1666	1	66	16	700
	C/FP-1672	1	72	16	750

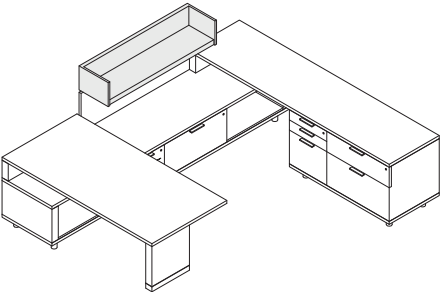
WALL-HUNG SHELF	MODEL NUMBER Specify (W)ood or (L)aminatE	DIMENSIONS			PRICE	
		D	W	H	(W)OOD	(L)AMINATE
	C/SH-30-W-()	14	30	10	775	700
	C/SH-36-W-()	14	36	10	875	800
	C/SH-42-W-()	14	42	10	975	900
	C/SH-48-W-()	14	48	10	1075	975
	C/SH-54-W-()	14	54	10	1175	1075
	C/SH-60-W-()	14	60	10	1275	1150
	C/SH-66-W-()	14	66	10	1375	1250
	C/SH-72-W-()	14	72	10	1475	1350

BOOKCASES

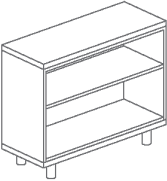
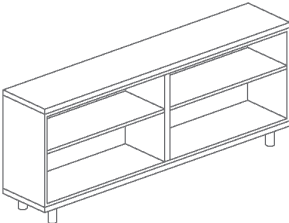
BOOKCASES	MODEL NUMBER Specify (W)ood or (L)aminiate	DIMENSIONS			PRICE	
		D	W	H	(W)OOD	(L)AMINATE
	30" WIDE					
	C/B-30-2H	14	30	29	1325	1200
	C/B-30-3H	14	30	44	1850	1675
	C/B-30-4H	14	30	57	2500	2250
	C/B-30-5H	14	30	70	3000	2700
	36" WIDE					
	C/B-36-2H	14	36	29	1500	1350
	C/B-36-3H	14	36	44	2100	1900
	C/B-36-4H	14	36	57	2550	2300
	C/B-36-5H	14	36	70	3375	3050
	60" & 72" WIDE					
	C/B-60-2H	14	60	29	2400	2175
	C/B-72-2H	14	72	29	2750	2475

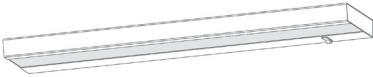
TASK LIGHT	MODEL NUMBER	DIMENSIONS			PRICE
		D	W	H	
	C/TL-30	8	30	1	400
	C/TL-36	8	36	1	425
	C/TL-42	8	42	1	450
	C/TL-48	8	48	1	475
	C/TL-60	8	60	1	500

TASK LIGHT WITH SHROUD	MODEL NUMBER	D	W	H	PRICE
	C/TLS-24	8	24	2	450
	C/TLS-36	8	36	2	475
	C/TLS-48	8	48	2	500
	C/TLS-60	8	60	2	550

PUCK LIGHT	MODEL NUMBER	D	W	H	PRICE
	C/PL-6	6	6	1/2	400

VOICE DATA POWER UNITS	MODEL NUMBER	D	W	H	PRICE
	C/IV-G2 (4-Pwr-2-USB-2-Data)	5 3/8	9		500
	C/G2 (4-Pwr/2-USB/2-Data)	6 1/2	14 1/4		650
	C/IF-11 TT (8-Pwr/8-Telecom Plates)	11	13 3/4		900



Architectural Response Kollection
2918 Halladay Street
Santa Ana, CA 92705
714.241.7100
info@ark-inc.com
ark-inc.com